

nobis
YOUR STOVE, OUR PASSION

EN - Installation, use and maintenance manual

H14 V SHAPE ROUND
H17 V SHAPE ROUND



Dear Customer. Thank you for choosing a product from our range.

You are invited to read this manual carefully before using the product, so as to take full advantage of all its features in complete safety.

This manual contains information necessary for correct installation, start-up, use, cleaning and maintenance of the product.

Please keep the manual in a suitable place after consulting it carefully.

Improper installation, incorrect maintenance and/or misuse of the product relieve the manufacturer of any liability towards people or property.

All rights reserved. No part of this instruction manual may be reproduced or transmitted by any electronic or mechanical means, including photocopying, recording or any other storage system, for no purposes other than the purchaser's personal use only, without express permission of the Manufacturer.

MANUAL INDEX

1 Introduction	4	9 Menu browsing	23
1.1 Symbols	4	10 First start-up instructions	24
1.2 Intended use	4	10.1 Hour-date settings	24
1.3 Improper use	4	10.2 Probe adjustments	24
1.4 Importance of the manual	4	10.3 Room temperature settings	24
1.5 General safety warnings	4	10.4 Fireplace power settings	24
1.6 Legal warranty	5	10.5 Switching ON/OFF the product	25
1.7 Exclusions from the warranty	5	11 Operation	25
1.8 Spare parts	6	11.1 Saving mode	25
1.9 Identification plate	6	11.2 Comfort Clima function	25
1.10 Disposal of the product	6	11.3 H ₂ O StandBy	27
1.11 Hermetic product	6	11.4 Ventilation management	27
2 Characteristics of the pellet	6	12 Description of the menu functions	27
3 Installation	7	12.1 Thermostat with timer function	27
3.1 Air intake	7	12.2 Auger loading function	28
3.2 Smoke channel and fittings	7	12.3 Pellet/Air-Intake ratio	28
3.3 Chimney flue	8	12.4 Stove status	29
3.4 Chimney stack	8	12.5 Enabling the external thermostat	29
3.5 Installation of the hermetic product	8	12.6 Season	30
3.6 Examples of proper installation	9	12.7 Language	30
3.7 Documents to be issued	10	12.8 Contrast	31
3.8 Unpacking the product	10	12.9 FW version	31
3.9 Coating installation	11	12.10 Anticondensation	31
3.10 Hydraulic connection	12	12.11 SLEEP function	29
3.11 Electrical connection	13	13 Advanced hydraulic diagrams	32
4 Examples of hydraulic diagrams	14	13.1 Diagram 01 (DHW tank + heating)	32
5 Maintenance	18	13.2 Diagram 02 (TECH. WTR. tank)	33
5.1 Maintenance of the smoke system	18	13.3 Diagram 03 (TECH. WTR. + DHW tank)	33
5.2 Product maintenance	18	14 Phases overview	34
6 Technical data of the product	18	15 Functions overview	34
6.1 Product data sheet	18	16 Alerts overview	34
6.2 Technical features	18	17 Anomalies overview	35
6.3 Dimensions	19	18 Description of alarms	35
6.4 Safety distances	19	19 Cleaning the appliance	38
7 Product configuration	19	19.1 Cleaning the fireplace	38
7.1 Configuration of the remote control	19	19.2 Cleaning the glass door	39
7.2 Configuration of ext. thermostat	20	19.3 Cleaning the ash pan	39
7.3 Pellet loading	20	20 Wiring diagram	41
8 Description of remote control commands	21		
8.1 Description of receiver	21		
8.2 Description of remote control keys	21		
8.3 Description of remote control display	22		
8.4 Flat battery signalling	22		
8.5 Concise icons diagram	23		

1 INTRODUCTION

Nobis products are designed and manufactured in compliance with the reference standards for manufacturing products (EN13240 wood stoves, EN14785 pellet appliances, EN13229 fireplaces/ wood-burning inserts, EN12815 wood-burning cookers), with high quality materials. The products also comply with the essential requirements of Directive 2006/95/EC (Low Voltage) and Directive 2004/108/EC (Electromagnetic Compatibility).

Any printing, translation and reproduction, even partial, of this manual are intended bound to the manufacturer's authorization, and the content of operating logics and explanatory figures is considered not to be disclosed.

Always consult authorized technicians in case of any doubts about the functioning of the product.

The manufacturer reserves the right to make changes to specifications and technical and/or working features of the product at any time and without prior warning.

1.1 SYMBOLS

This manual contains symbols highlighting the importance of particular descriptions or concepts;

 **INFORMATION:** complying with the product's specifications guarantees its correct operation.

 **WARNING:** this symbol is used to identify information of particular importance.

 **DANGER:** the presence of this symbol indicates that utmost attention is required to guarantee both user and product safety.

1.2 INTENDED USE

This is a manual for a fireplace for domestic heating, fed by automatic loading and using wood pellets only.

This product has been designed and manufactured to work in safety if the following conditions occur:

- installation by specialized staff in compliance with the specific reference standards;
- use within the limits declared on the product data sheet and in this manual;
- compliance with technical procedures as described in the manual;
- carrying out routine maintenance according to times and methods indicated in this manual;
- prompt execution of extraordinary maintenance if necessary (e.g. in case of malfunctioning);
- the safety devices are working properly and maintained on a regular basis (do not remove or bypass this devices).

1.3 IMPROPER USE

The product is intended to be used for the purposes and within the limits for which it was expressly designed; for any other use, the manufacturer cannot be held in any way liable for damage caused to people, animals or property.

Improper use is meant as:

- using the product as an incinerator;
- use of the product with fuel other than Ø 6mm wood pellets;
- Fuelling the product with liquid fuel;
- using the product with the fire door open and/or broken glass and/or ash pan removed and/or pellet tank open.

Any other use of the appliance other than that for which it has been intended must be authorized in advance in writing by the manufacturer.

Furthermore, the manufacturer cannot be held in any way liable for any mistakes in the installation, adjustment or maintenance of the product.

1.4 IMPORTANCE OF THE MANUAL

This manual has the purpose of providing essential rules for proper installation, use and maintenance of the product.

STORAGE: please, store the manual in a place that is easy and quick to find;

DETERIORATION OR LOSS: please, consult our official website to download the manual;

PRODUCT TRANSFER: In the event of sale of the product between private individuals, the owner is obliged to deliver the product with a copy of this manual included.

1.5 GENERAL SAFETY WARNINGS

Non-compliance with the provisions of this manual can cause damage to people, animals and property.

- Installation, testing of the system, functionality testing and initial calibration of the product must be carried out by qualified and authorized staff only.
- The product must be connected to a single chimney flue guaranteeing the draught declared by the manufacturer and complying with the installation standards outlined in the place of assembly of the product.
- The premises where the product is installed must be adequately ventilated (air intake).
- Do not touch the hot surfaces without adequate protective equipment, so as to avoid burns.
- When in operation, the external surfaces of the product reach high temperatures.
- It is forbidden to make any changes to the product unless expressly communicated in writing by the manufacturer.
- In the event of fire in the chimney flue, please contact the fire brigade immediately.

- The product can be used by children over 8 years of age and people with reduced physical, sensor or mental capacity, or without experience or the necessary know-how, provided that they are supervised, or have received instructions on the safe use of the appliance and are aware of the dangers an improper use may involve. Children must not play with the appliance.
- Cleaning and maintenance intended to be carried out by the user must not be carried out by children without supervision.
- Do not dry the laundry on the the product.
- The fuel and other flammable materials must be kept at a suitable distance from the product. Fire hazard.
- The product must be electrically connected to a system equipped with a suitable grounding system.
- In the event of a fault in the switch-on system, do not force ignition using flammable material. Consult an authorized technician.
- For non-hermetic products, installation in small rooms and bedrooms is forbidden.
- Installation is forbidden in environments with an explosive atmosphere.
- all parts resulting as being faulty due to negligence or careless use, wrong maintenance, or installation non-conforming to the manufacturer instructions (please, refer to the installation and use manual supplied with the appliance);
- further damage caused by wrong intervention by the user in the attempt to solve a preexisting fault;
- aggravated damage caused by further use of the appliance by the user once a fault has occurred;
- in the presence of a boiler, any corrosion, scale or breakages caused by stray current, condensate, abrasion or acidity in the water, scale removal treatments carried out improperly, water shortage, sludge or limescale deposits;
- inefficiency of the chimneys, chimney flues or parts of the system on which the appliance depends;
- damage caused by tampering with the appliance, atmospheric agents, natural disasters, vandalism, electrical discharge, fire, faulty electrical and/or plumbing system.

The following are also excluded from the warranty:

- parts subject to normal wear such as gaskets, glass, coverings and cast iron grates, painted, chrome-plated or gold-plated parts, handles and electrical cables, lights, switch resistor, indicator lights, knobs, and all those parts that can be removed from the fireplace (e.g. refractory, brazier);
- color variations of painted and ceramic parts, as well as ceramic cracks (being natural features of the material and consequent to use of the product);
- masonry works;
- parts of the system (if present) not supplied by the manufacturer;

Therefore, any technical interventions on the product for the elimination of the aforementioned defects and consequent damages must be agreed with the Technical Assistance Center, which reserves the right to accept or refuse the relevant assignment and in any case will not carry out the task as a guarantee, but as technical assistance to be provided under the conditions possibly and specifically agreed and according to the rates in force for the work to be carried out. The user will also be charged for the costs that may become necessary to remedy his/her incorrect technical interventions, tampering or, in any case, factors which can be harmful to the device and that cannot be attributed to manufacturing defects. Without prejudice to the limits imposed by laws or regulations, any warranty of containment of air and noise pollution is also excluded.

1.6 LEGAL WARRANTY

To benefit from legal warranty, the user must strictly comply with the provisions indicated in this manual. In particular, the user will have to:

- always work within the use limitations of the product;
- always carry out routine maintenance;
- authorize the use of the machine only to people with proven capacity, attitudes and who are adequately trained for the purpose;
- use original spare parts specifically intended for the appliance model in use.

It is also necessary to provide the following:

- fiscal receipt reporting date of purchase;
- a certificate of compliance for the installation of the product, issued by authorized staff.

Non-compliance with the provisions contained in this manual will imply immediate forfeiture of the warranty for both the product and any spare parts assembled thereafter.

1.7 EXCLUSIONS FROM WARRANTY

The warranty excludes all malfunctions and/or damage to the appliance resulting from the following causes:

- damage caused by transport and/or handling;

1.8 SPARE PARTS

Please, use only original spare parts.

Do not wait for the components to wear from use before replacing them.

This measure is intended to prevent accidents to people, animals or property from occurring in the event of product malfunctioning caused by defective spare parts.

We recommend you to contact authorized staff for the replacement of spare parts, worn parts and to carry out extraordinary maintenance.

1.9 IDENTIFICATION PLATE

The plate placed on the back of the product outlines all the characteristic data of the appliance, including the Manufacturer's data, serial number and CE marking.

1.10 PRODUCT DISPOSAL

Demolition and disposal of the product is at the sole responsibility of the user, who should do so in compliance with legislation in force in his country concerning safety matters, respect and safeguard of the environment.

At the end of its useful life, the product must not be disposed of as urban waste.

It can be delivered to specific differentiated waste collection centres made available by municipal administrations, or dealers providing this service.

Disposing of the product as differentiated waste means avoiding any possible negative consequences for both health and environment deriving from inadequate disposal. Furthermore, it allows for the recovery of the materials the product is made with, so as to obtain important savings in energy and resources.

1.11 HERMETIC PRODUCT

Products manufactured with a perfectly hermetic structure do not consume oxygen in the environment, for they take all the air they need outdoor (when properly installed). Therefore, they can be positioned inside all homes with a high level of insulation, such as "passive houses" or with "high energy efficiency". Thanks to this technology, there is no risk of smoke emissions in the environment and no ventilation grates are necessary.

As a result, no cold air flows - which can make the environment less comfortable and reduce the overall efficiency of the system- are created. Hermetic products can also be installed in the presence of forced ventilation or in premises which can go into negative pressure - if compared to the outside.

2 CHARACTERISTICS OF PELLETS

Wood pellets are fuel made from pressed sawdust, often recovered from carpentry processing waste. The material used cannot contain any foreign substances such as glue, varnish or other synthetic substances.

After being dried and cleaned of impurities, sawdust it is pressed by means of a matrix: the sawdust heats due to high pressure, activating the natural binders in the wood; by doing so, pellets maintain their shape even without adding artificial substances. The density of wood pellets vary according to the type of wood and can be up to 1.5 or twice as much that of natural wood. Pellet cylinders have a diameter of 6mm and a variable length of 10 to 40mm.

Their density is equal to approx. 650 kg/m³. Due to their low water content (< 10%), they have a high energy content.

The main quality certifications for pellets existing on the European market make it possible to guarantee that the fuel falls into class A1 according to ISO 17225-2: 2014 (ex EN 14961). Examples of these certifications are ENPlus, DINplus, Ö-Norm M7135. In particular, such certifications guarantee that the following characteristics are observed:

- heating power: 4.6 ÷ 5.3 kWh/kg;
- water content: ≤ 10% of weight;
- percentage of ash: max 1.2% of weight (A1 under 0.7%);
- diameter: 6±1/8±1 mm;
- length: 3÷40 mm;
- content: 100% untreated wood without any additional binder substances (percentage of bark max 5%);
- packaging: in sacks made from ecocompatible or biodegradable material.

 For its products, the manufacturer suggests use class A1 certified fuel complying with EN ISO 17225-2:2014 standard, certified DIN PLUS (more restrictive than class A1) or else O-NORM M7135.

 Pellets must be stored in a dry environment which is not excessively cold. We also suggest you to keep some bags of pellets where the product is installed and operating, so as to dry any humidity in them. Non-compliance with this aspect reduces the fuel thermal power. This means that the product will need greater maintenance.

3 INSTALLATION



When installing and using the the product, all local, national legislation and European standards must be met.

When installing the product, the position must be chosen according to the environment, the discharge and the chimney flue. Check with your local authority whether there are more restrictive provisions regarding the combustion air intake and the smoke discharge system, including the chimney flue and chimney pot.

The manufacturer cannot be held in any way liable in the event of installation non-compliant with current legislation, of incorrect air exchange in the premises, or electrical connection non-conforming with standards and/or inappropriate use of the appliance. Installation must be carried out by a qualified technician who will provide the purchaser with a Declaration of Conformity for the system and will assume complete responsibility for final installation and resulting good operation of the product.

In particular, he should ascertain the following:

- that there is an adequate combustion air intake and good smoke discharge compliant with the type of product installed;
- other stoves or devices installed do not cause negative pressure in the room where the product is installed (only for hermetic appliances, a maximum of 15 Pa depression in the surroundings is permitted);
- when the product is on, there is no smoke back draught in the environment;
- smoke evacuation is implement in total safety (dimensioning, smoke seal, distances from flammable materials..).

Once the position where to install the product is decided, you need to pay attention to the following:

- if the floor is made of combustible material, you should use protection in suitable material (steel, glass...), also to protect the front part from any burning fuel which may fall while during cleaning;
- the floor guarantees adequate load capacity.

if the existing building does not meet the aforementioned requirements, you should take appropriate measures (for example a load distribution plate).

3.1 AIR INTAKE

The installation premises of non-hermetic appliances must be sufficiently ventilated with specific openings, with particular attention to the position (they must NEVER be blocked), which allow for air reintegration in the environment.

Air must be drawn directly from the outside (not from other rooms, garage, etc.) and must have a net useful section equal or higher than 80 cm² for pellet stoves and thermostoves (EN 14785) and 100 cm² for boilers (EN 303-5).

The air intake is not necessary in case of installation of hermetic appliances that take the air directly from the outside. Check and respect the ventilation requirements for simultaneous operations with other combustion appliances and in the presence of forced ventilation systems or hoods (please, see section 6.4 of UNI 10683).

3.2 SMOKE CHANNEL AND FITTINGS

'Smoke channel' is a term indicating the piping connecting the combustion appliance with the chimney flue.

For heat-generating appliances equipped with an electric fan to expel smoke, the following installation instructions must be followed (provided by the manufacturer and concerning the maximum length and number of curves the smoke channels can have).

If no indications for maximum values - or deriving from preliminary calculations, according to UNI EN 13384-1 - are given, the following provisions must be applied:

- comply with the EN1856-2 standard;
- the horizontal sections must have at least 3% upward slope;
- the length of the horizontal section must be minimal and its projection on plan must not exceed 4 meters;
- the number of changes of direction - including that for introduction into the chimney and excluded that due to the use of a "T" element in appliances with rear smoke outlet - must not be more than 3;
- the changes of direction must not have an angle exceeding 90° (a 45° curve is recommended);
- the section must have constant diameter, equal to the output of the fireplace up to the fitting in the chimney flue;
- it is forbidden to use flexible metal and fiber cement piping. Moreover, the piping must guarantee pressurized sealing;
- Smoke channels must not cross those premises in which installation of combustion appliances is forbidden;
- Use watertight piping with silicone gaskets.

In any case, smoke ducts must be sealed against combustion products and condensate, and must be insulated in case they run through the outside of the installation room. The installation of manual draught adjustment devices on forced draught appliances is not permitted.



It is necessary, at first, to install a vertical smoke channel section of at least 1 m to guarantee proper exhaust of fumes.

3.3 CHIMNEY FLUE

When installing the chimney flue, the following must be applied.

- compliance with EN 1856-1 product standard;
- it must be installed using materials suitable to guarantee resistance to normal mechanical and chemical stress, and have a correct insulation, to avoid formation of condensate. Therefore, it must be hermetically insulated;
- it must develop mainly vertically and it must not be choked along its length;
- be correctly spaced using air cavities and insulated against flammable materials,
- changes in its direction must be no more than 2 and with an angle not exceeding 45°;
- the indoor portion of the chimney flue must nonetheless be insulated and it can be inserted in a cavedium, provided that this complies with the relevant piping standards;
- the smoke channel should be connected to the chimney flue using a "T" joint with an inspectionable collection chamber (for the collection of fuel residue and, particularly, condensate).



It is not possible to connect the appliance to a chimney flue shared with other combustion appliances or in the presence of hood exhausts.



It is forbidden to use direct wall discharge or towards closed spaces or any other form of discharge not planned by current legislation in the country of installation (e.g.: in Italy, only roof discharge is permitted)



It is recommended to check safe distances, which must be observed in the presence of combustible materials, and the type of insulating material to be used (such data are made available on the chimney flue plate).

3.4 CHIMNEY STACK

UNI 10683 standard states that the stack must meet the following characteristics:

- the smoke outlet section must be at least double the inner section of the chimney;
- the stack must be shaped to prevent water or snow from penetrating;
- the stack must be built in such a way that wind cannot affect the smoke outlet (wind-proof cap);
- the opening measurement, which is measured between the lower coverage protective layer and the lower point of the smoke outlet section into the atmosphere, must be outside the back draught area;
- the stack must be built far from antennas or satellite dishes and must never be used as a support.

3.5 INSTALLATION OF THE HERMETIC PRODUCT

In the event of installation of a hermetic product, you can connect it with the piping system by choosing one of the following:

- smoke discharge (1) and recovery of combustion air directly from the outside (2).

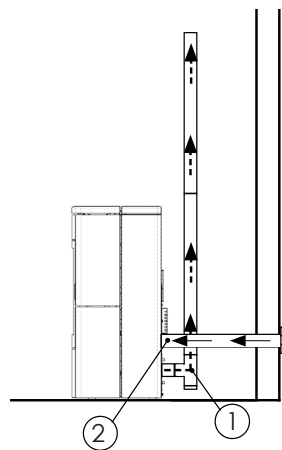

- smoke discharge (1) and combustion air canalization (2), taking advantage of its coaxial discharge to expel smoke and draw air in; therefore, the installation of a grate to recirculate the air inside the premises where the product is placed is not necessary.

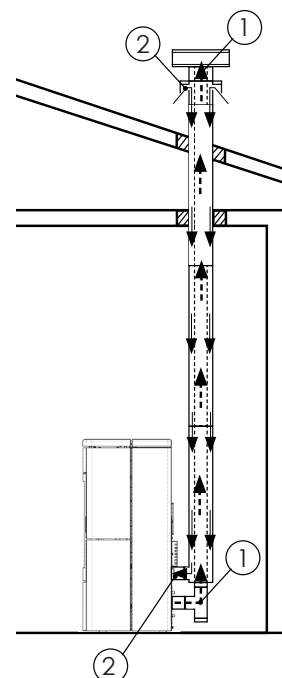

For coaxial installation or for drawing air directly from the outside, it is recommended not to exceed 2.5/3 linear meters, in order to ensure proper oxygen supply to combustion.

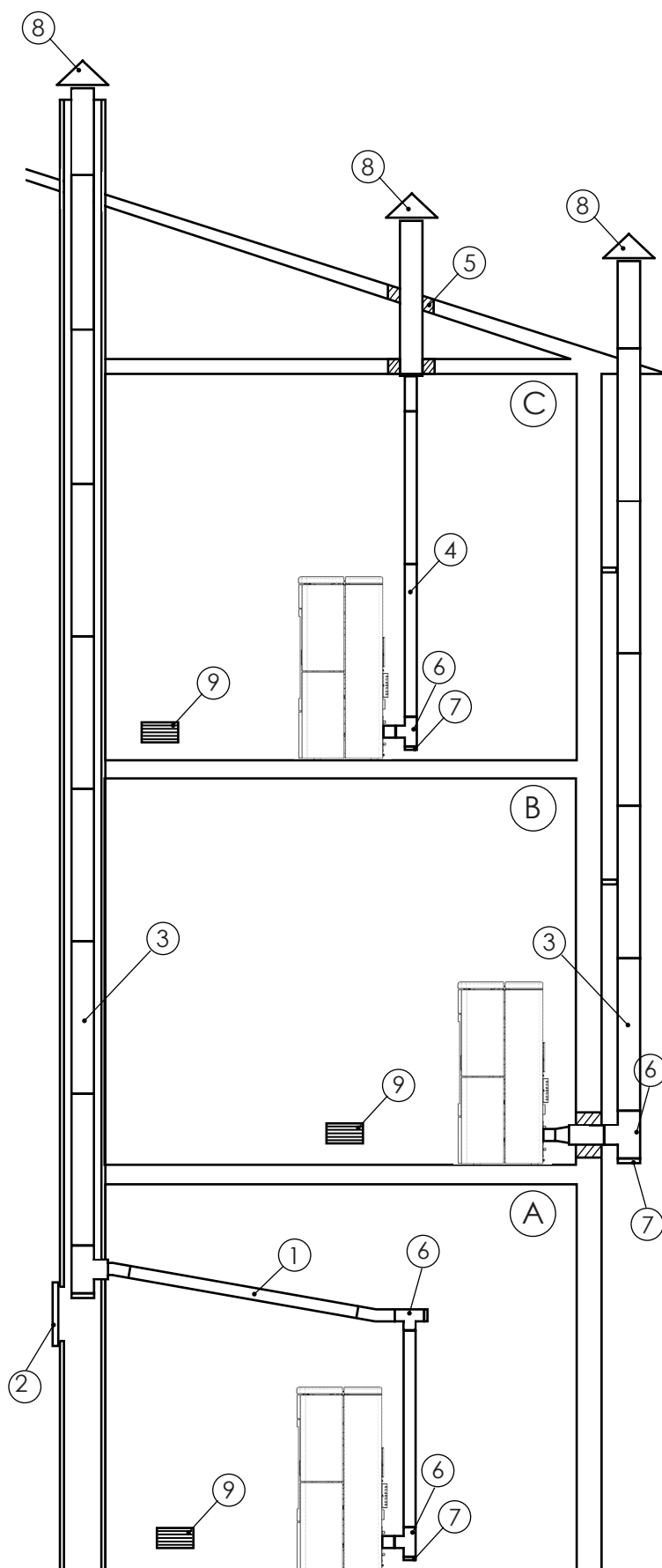

3.6 EXAMPLES OF PROPER INSTALLATION

A proper installation of the product (A) needs for a horizontal section to connect it to a pre-existing chimney flue. A slope of 3-5% must be observed, so as to reduce ash deposit in the horizontal pipe section - which must not exceed 3m in length (1). The pre-existing chimney flue must be inspectionable (2).

An insulated chimney flue (3) with an internal diameter of no less than 100mm is necessary to install the product (B), since the smoke piping system has been assembled outside the building.

A single-wall chimney flue (4) for the section inside the building is also needed for a proper installation of the product. Relating to the part placed in the attic, it is recommended to install a $\varnothing 120\text{mm}$ chimney flue, with perforation for the passage of the piping, increased of:

- minimum 100mm around the pipe, if in contact with inflammable parts such as cement, bricks, etc.;
- minimum 300mm around the pipe (or as described in the data shown on the plate) if in contact with flammable parts such as wood etc.

In both cases, please provide with adequate insulation the space between the chimney flue and the attic (5).

It is also recommended to check and comply with the data shown on the plate of the chimney flue, particularly the safety distances to be observed from combustible materials.

The previous rules also apply for holes made on walls.

On both the lower part and on the inlet of the chimney flue, for all 3 installations, a "T" fitting (6) equipped with inspection plug (7) is employed.

The upper part of the chimney flue, for all 3 installations, is equipped with a wind-proof chimney pot (8).

For each installations, a grate has been provided inside the building to guarantee correct oxygenation of the premises where the product is positioned.

The grate is not necessary if the appliance is hermetically sealed.

! It is not recommended to install a 90° curve as an initial section, for it would cause ash to block the smoke passage quickly, resulting in draught inefficiency in the appliance.

! In the event of particular atmospheric conditions and/or hostile draught conditions, the product can overcome these situations provided that due installation measures have been taken, e.g. installation of a wind-proof chimney pot.

3.7 DOCUMENTS TO BE ISSUED

Once the installation has been carried out, the technician must provide to the user with the following:

- use and maintenance booklet of the appliance supplied by the manufacturer;
- technical documents of all the accessories used and subject to maintenance;
- documents related to the exhaust system;
- system booklet (when applicable);
- installation certificate;

Documentation useful for liability purposes of the installer must include:

- a detailed description (also including photographs) of the presence of other heat generators;
- Declaration of Conformity of the system (M.D. 37/08);
- general description, diagram or photographic documentation of changes made to the system, if any intervention is necessary during installation;
- Use of certified material with the CE mark (305/2011);
- possible instructions related to the warranty;
- date and signature of the installer;



NOBIS SRL cannot be held in any way liable in the event of non-compliance with the installation and start-up standards of its products.

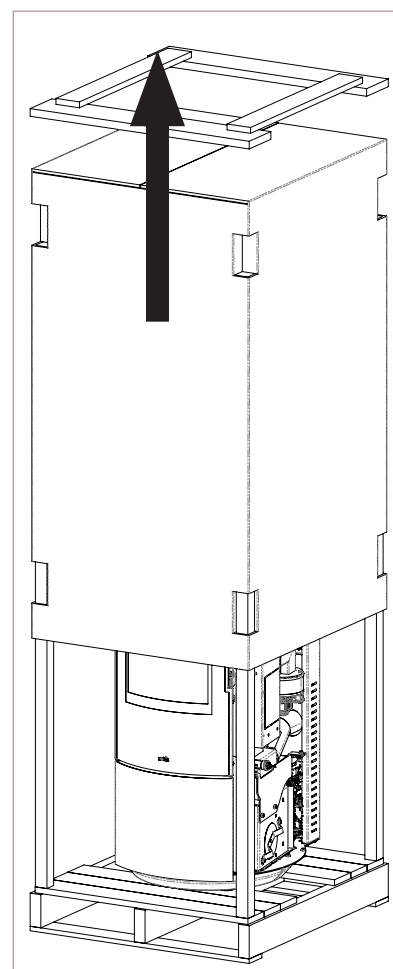

Fig.1

3.8 UNPACKING THE PRODUCT

Packaging is composed of boxes in recyclable cardboard complying with RESY standards and wooden pallets. All packaging materials can be re-used for similar use or, if necessary, disposed of as urban waste, in compliance with current laws.

Remove the strap binding the pallet to the packaging and lift the cardboard **Fig.1**; remove the plastic bag around the product, making sure it is intact.

The body must always be handled with a trolley, paying attention to keep it in a vertical position.

Make sure both the door and its glass are protected against mechanical impact which would compromise their integrity.

If possible, unpack the product near the area where it will be installed.

To release the appliance from the pallet, you can unscrew the two screws placed under the pallet (13 hex key). **Fig.2**

Position the equipment and proceed connecting it to the chimney flue.

By using the 4 adjustment feet, find the right level so that the smoke discharge and the pipe are connected correctly.

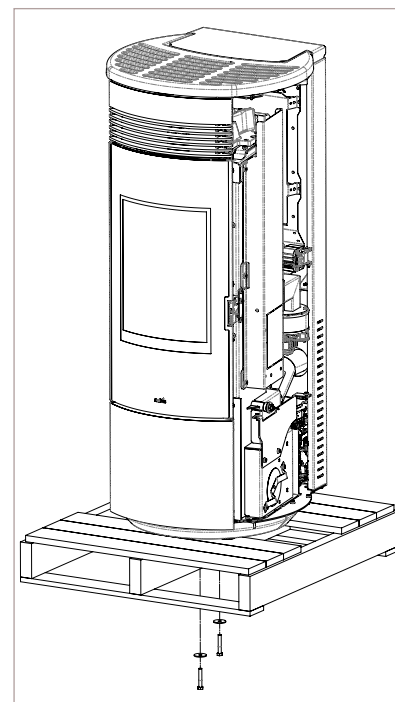

Fig.2

Fig.1

3.9 COATING INSTALLATION

Remove the cast iron upper part of the product.

Using the 8 hexagonal key, remove the 2 screws (size 8) on the top of the product and open the packaging containing the casing.

INSTALLATION OF SIDE PANELS

Remove the right side panel from the packaging and the panel into the pins on the base of the product (fig.1), bring the panel to a vertical position and secure the upper part with screws. Vertical position and secure the upper part with the screws previously removed, taking care alla linearità con la porta del prodotto (fig.1B).

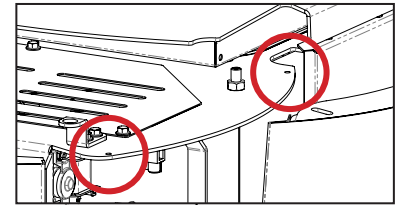

Fig.1A

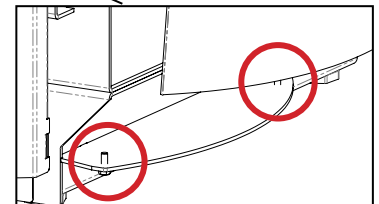
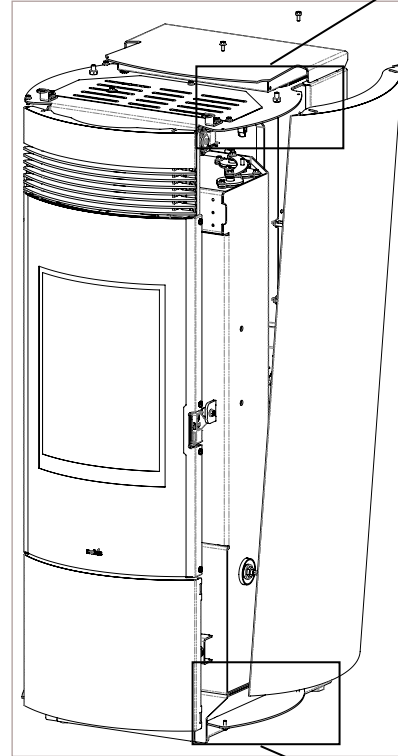
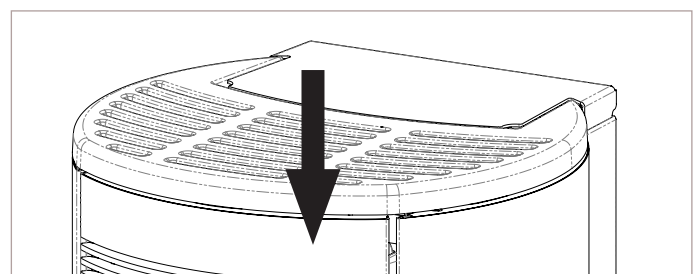

Fig.1B

Repeat both operations for mounting the opposite side.

When finished, reposition the cast-iron top.



Below is the final result.

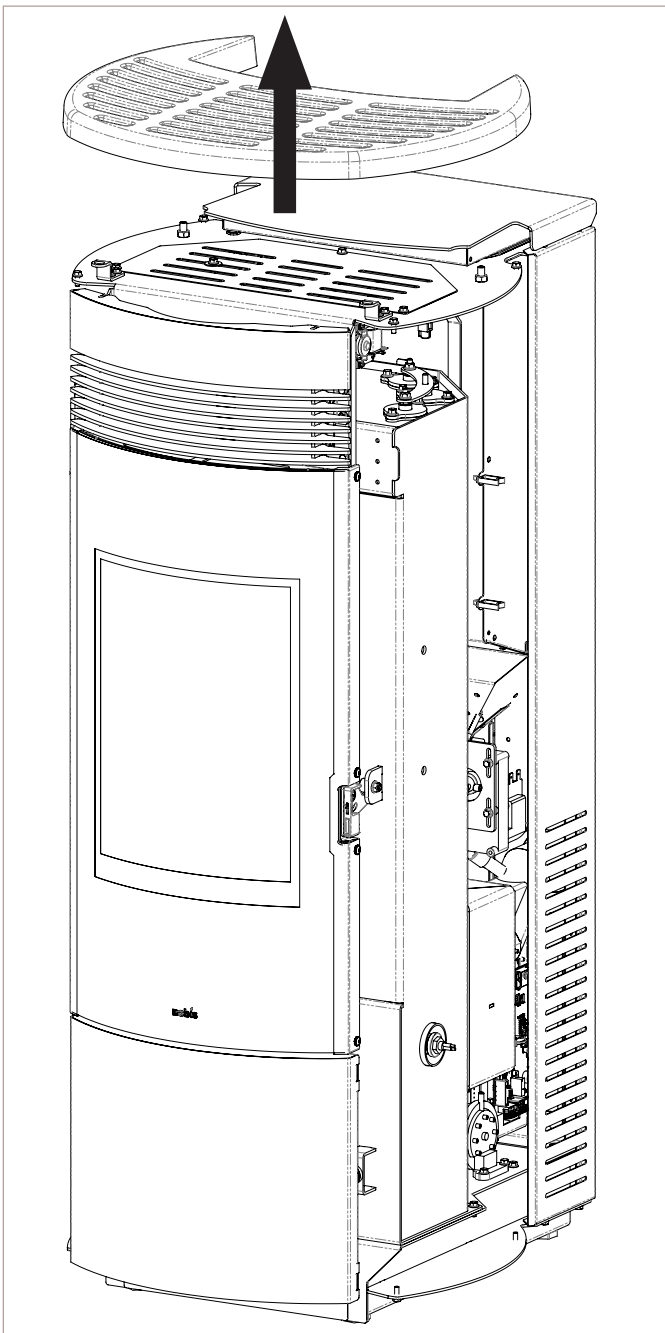

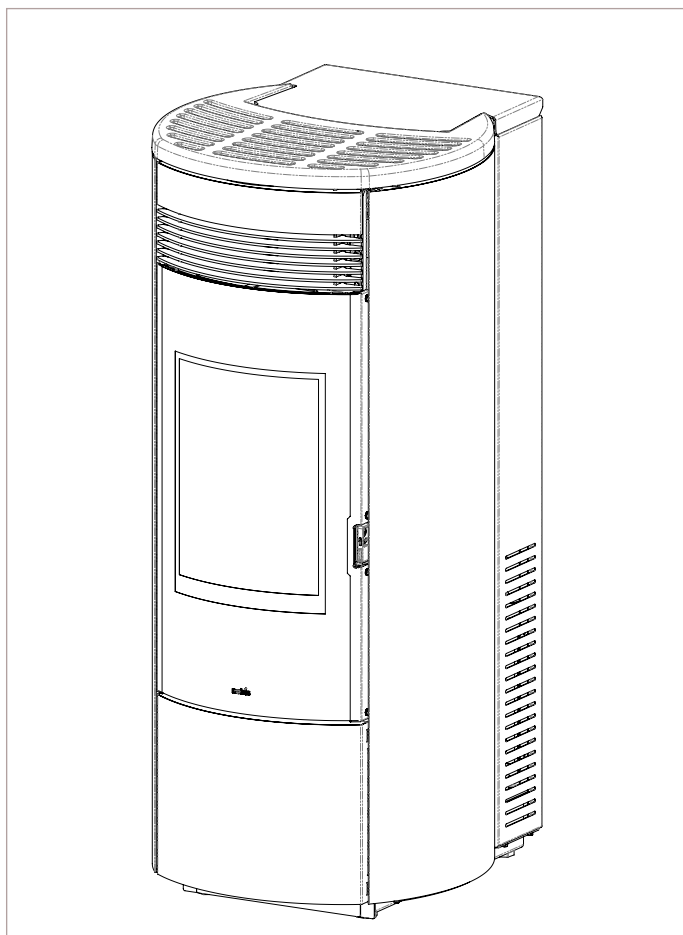

3.10 HYDRAULIC CONNECTION

This section of the manual illustrates all the steps to follow in order to connect the hydraulic system of the product to the house system.

! Product connection to the the house hydraulic system must be carried out exclusively by specialized personnel, able to perform the installation to perfection and complying with any existing provisions in the Country of Installation.

! In order to remove any residues and deposits, wash the entire system before connecting the product. Always install gate valves upstream of the product so as to isolate it from the water system, should it be necessary to move or relocate it to perform routine and/or extraordinary maintenance operations. Connect the appliance using flexible pipes to avoid overtightening it to the system and to allow slight movements.

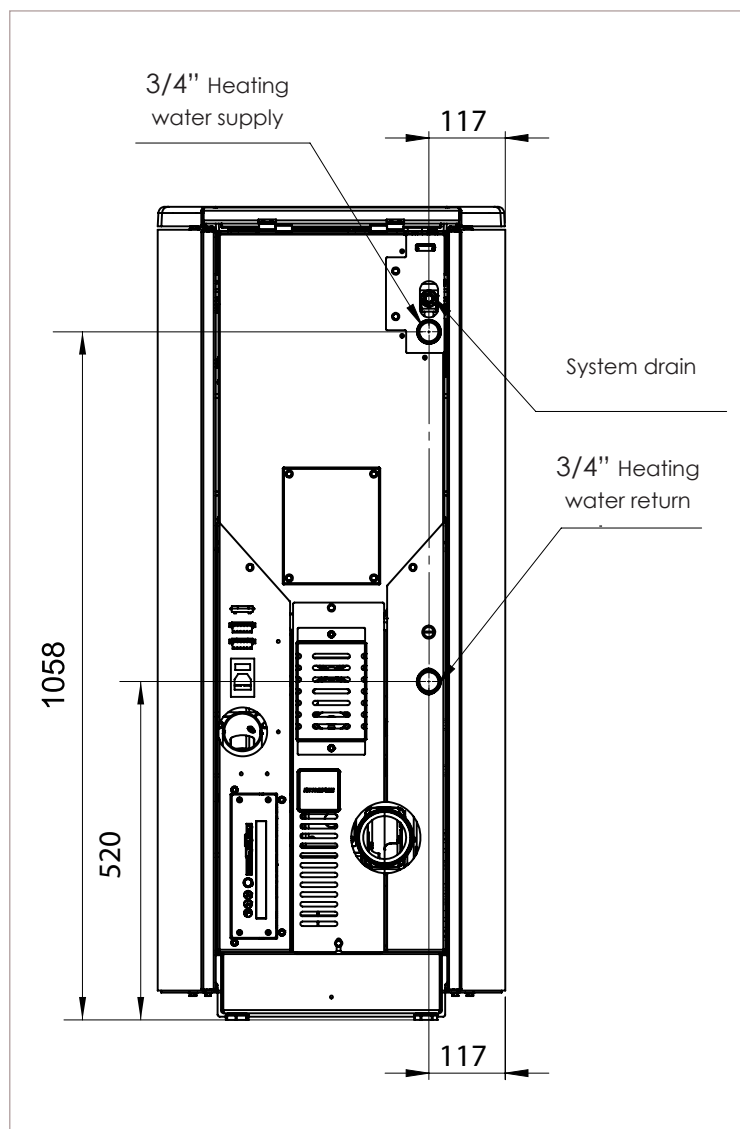

3-bar DRAIN VALVE

The inspectable safety valve is located on the back of the product. It is mandatory to connect a rubber pipe (not supplied) to the safety drain - able to withstand a temperature of 110 °C - to be taken outside for possible water outlet.

! The appliance manufacturer is not responsible for any flooding caused by the intervention of the safety valves in case of inaccurate connection to the outside of the product and to a proper collection and drain system.

SYSTEM CLEANING

Connections must be easy to disconnect by means of swivel fittings.

To preserve the heating system from harmful corrosion, scaling or deposits, flush the system using appropriate products - in compliance with the UNI 8065 standard (treatment of water in heating systems for civil use) - before installing the appliance is paramount.

EXPANSION VESSEL

In case of overheating the product is equipped with an expansion vessel to compensate for the increase in water pressure inside the boiler. Therefore, it is necessary to reckon whether the expansion vessel the product is equipped with is capable enough. Otherwise, please consider adding a supplementary expansion vessel.

SYSTEM FILLING

To fill the system, install a pipe in the dedicated inlet and, by opening the tap, proceed with the filling. During this operation, the venting of any air present in the system is guaranteed by an automatic air vent "Jolly valve" (supplied with the product). To allow the valve to vent, it is recommended to loosen the gray cap of one turn. The COLD system loading pressure must be 1 bar.

If system pressure happens to drop while operating (during evaporation of gases dissolved in the water) below minimum values - as indicated above - the User must act on the filling tap to bring it back to the initial value. For a proper HOT work of the appliance, the pressure in the boiler must be 1.5 bar. To monitor system pressure, fit a pressure gauge or display instantaneous pressure in STOVE STATUS. Always close the tap after the filling operation has been carried out completely.

WATER FEATURES

The characteristics of the water used for filling the system are very important to avoid mineral salt deposits and scaling along the pipes inside the boiler and in the exchangers.

Therefore, please pay attention to the following:

- Water hardness in the system, to prevent any issues due to scaling.
- Installation of a water softener if water hardness makes it necessary.
- Fill the system with treated water (demineralized).
- Possible installation of an anti-condensation circuit.
- Installation of hydraulic shock absorbers to avoid the so called "water hammer" effect along pipes and joints.



It must be remembered that scales drastically reduce performance due to their low thermal conductivity.

3.1.1 ELECTRICAL CONNECTION

The product power-supply cable must only be connected after concluding installation and assembly of the product, it must not be in contact with hot parts and must remain accessible after installation. To carry out electrical connection, proceed as described below:

- connect the power-supply cable on the back of the appliance;
- connect the cable plug to the electrical socket on the wall.



You can connect an outer programmable thermostat to the appliance for its regulation or to switch it on and off. For connection and management of the "outer thermostat" function, please see the specific chapter in this manual.



It is normal to hear noises and gurgling sounds: it means that the air in the system has not been completely removed.

4 EXAMPLES OF HYDRAULIC DIAGRAMS

DIAGRAM 00 - DIRECT CONNECTION TO THE SYSTEM

- 1 - Pellet stove
- 2 - Thermometer
- 3 - Pressure gauge
- 4 - Anti-condensation valve
- 5 - System separator
- 6 - System manifold
- 7 - Mixed distribution group
- 8 - Direct distribution group
- 9 - Gas boiler
- 10 - Water duct
- 11 - Sanitary water
- 12 - Wall thermostat
- 13 - Floor heating
- 14 - Heating with radiators
- 15 - Three-way heating valve
- 16 - DHW storage tank (Boiler)
- 17 - DHW flow switch
- 18 - Mixing valve
- 19 - Technical water storage tank (hot water tank)

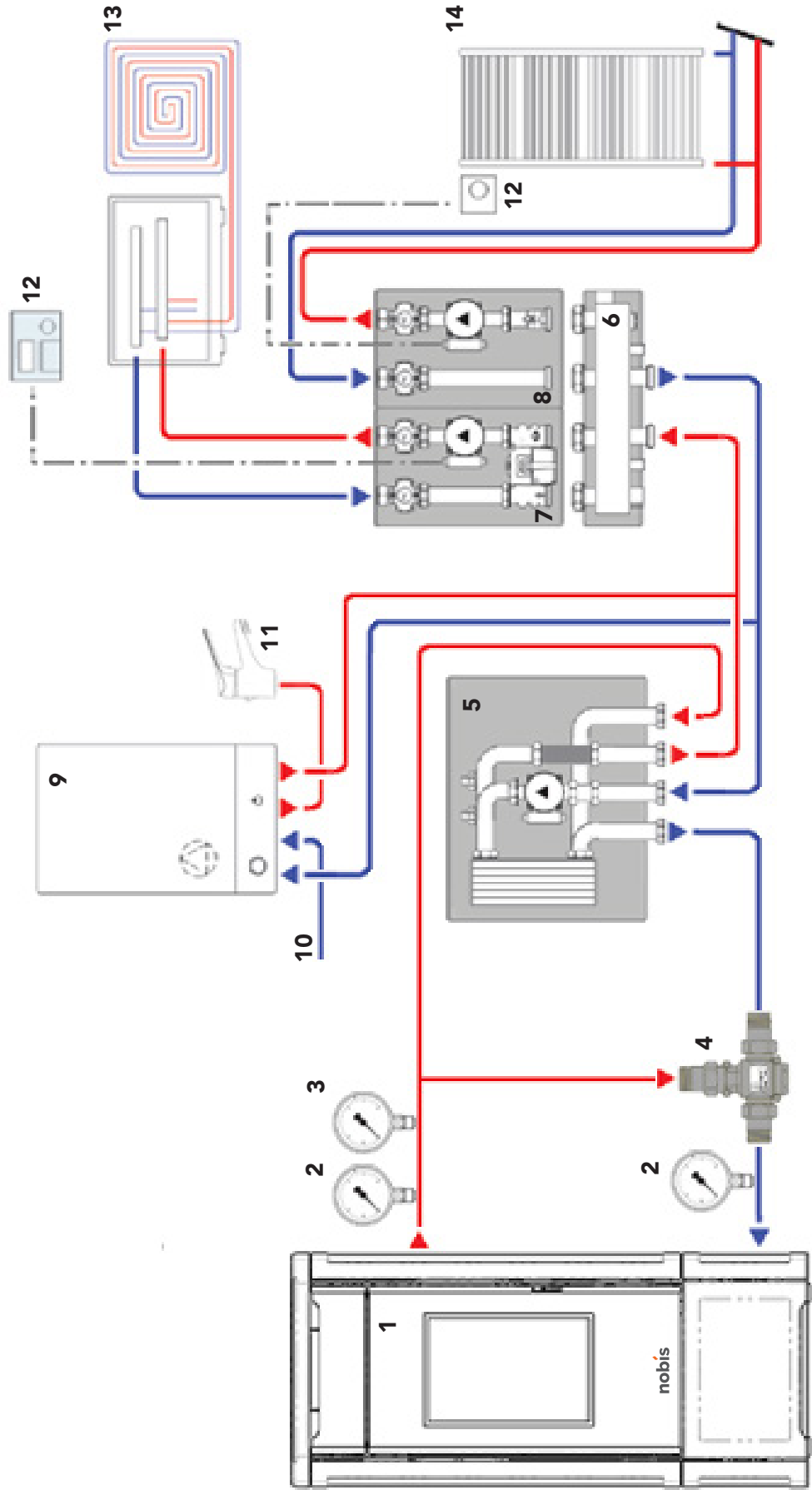

DIAGRAM 01 - DIRECT CONNECTION TO THE SYSTEM + DHW TANK

- 1 - Pellet stove
- 2 - Thermometer
- 3 - Pressure gauge
- 4 - Anti-condensation valve
- 5 - System separator
- 6 - System manifold
- 7 - Mixed distribution group
- 8 - Direct distribution group
- 9 - Gas boiler
- 10 - Water duct
- 11 - Sanitary water
- 12 - Wall thermostat
- 13 - Floor heating
- 14 - Heating with radiators
- 15 - Three-way heating valve
- 16 - DHW storage tank (Boiler)
- 17 - DHW flow switch
- 18 - Mixing valve
- 19 - Technical water storage tank (hot water tank)

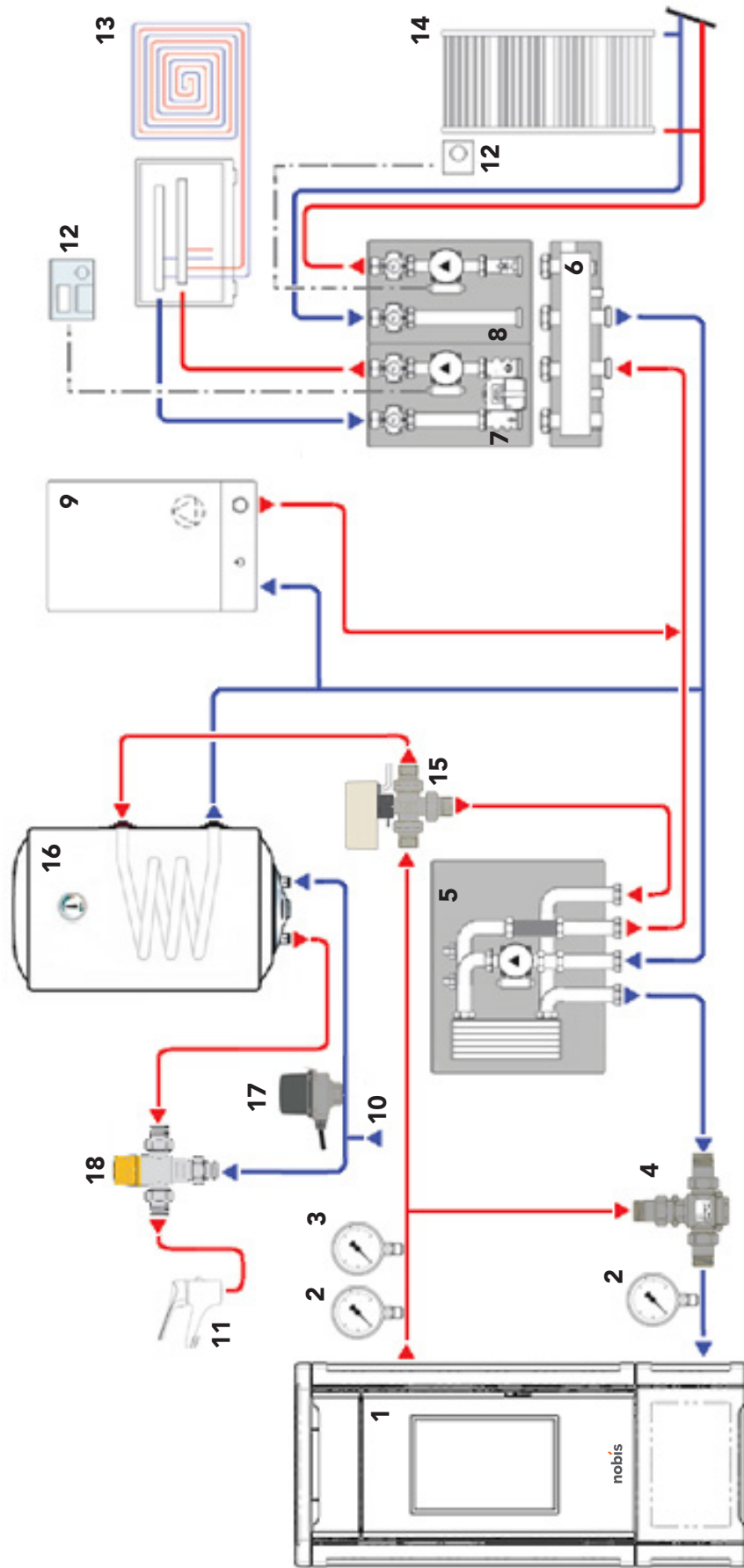

DIAGRAM 02 - TECHNICAL WATER TANK (PUFFER)

- 1 - Pellet stove
- 2 - Thermometer
- 3 - Pressure gauge
- 4 - Anti-condensation valve
- 5 - System separator
- 6 - System manifold
- 7 - Mixed distribution group
- 8 - Direct distribution group
- 9 - Gas boiler
- 10 - Water duct (heating/domestic)
- 11 - Sanitary water
- 12 - Wall thermostat
- 13 - Floor heating
- 14 - Heating with radiators
- 15 - Three-way valve (heating/domestic)
- 16 - DHW storage tank (Boiler)
- 17 - DHW flow switch
- 18 - Mixing valve
- 19 - Technical water storage tank (hot water tank)

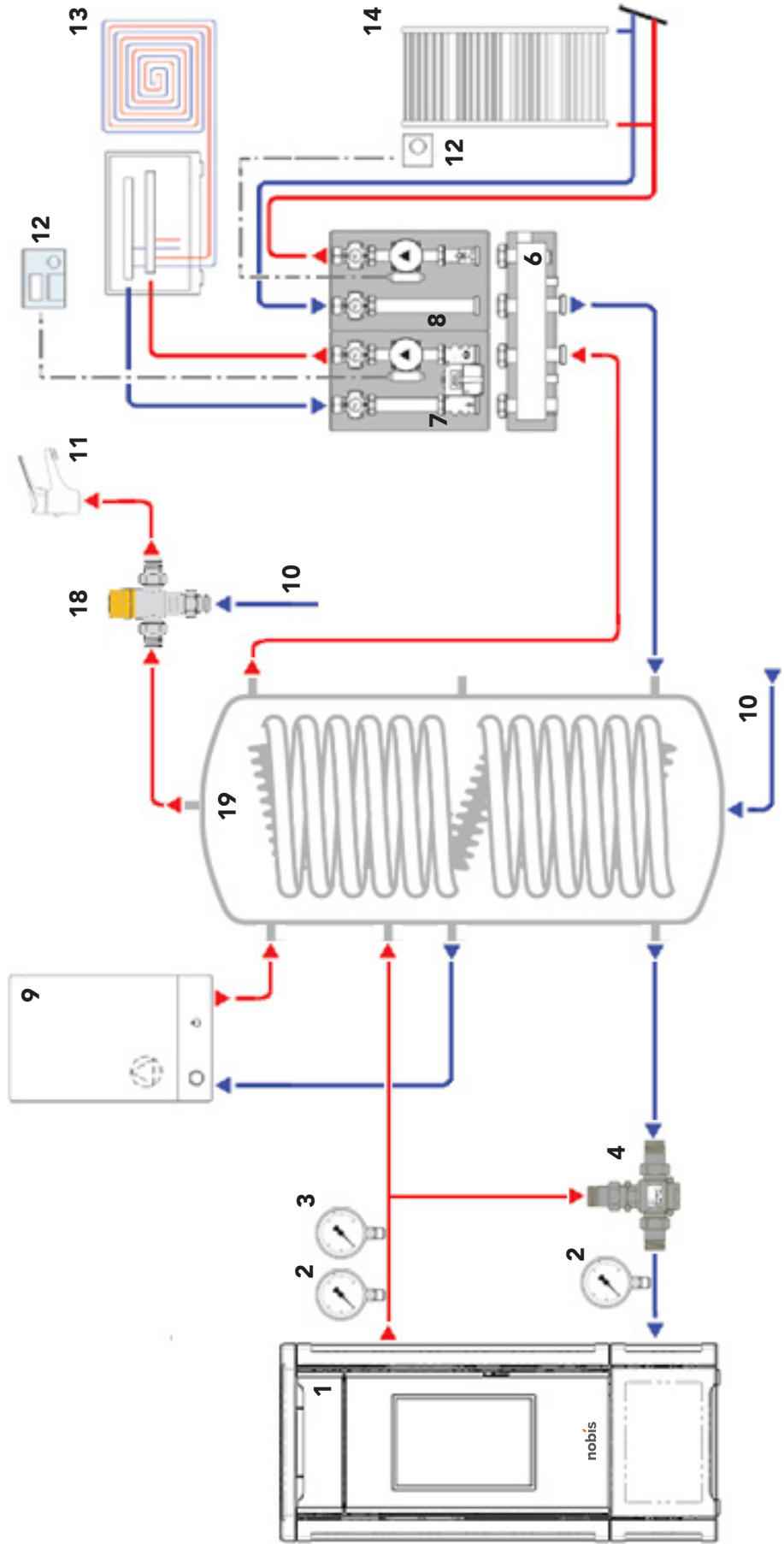
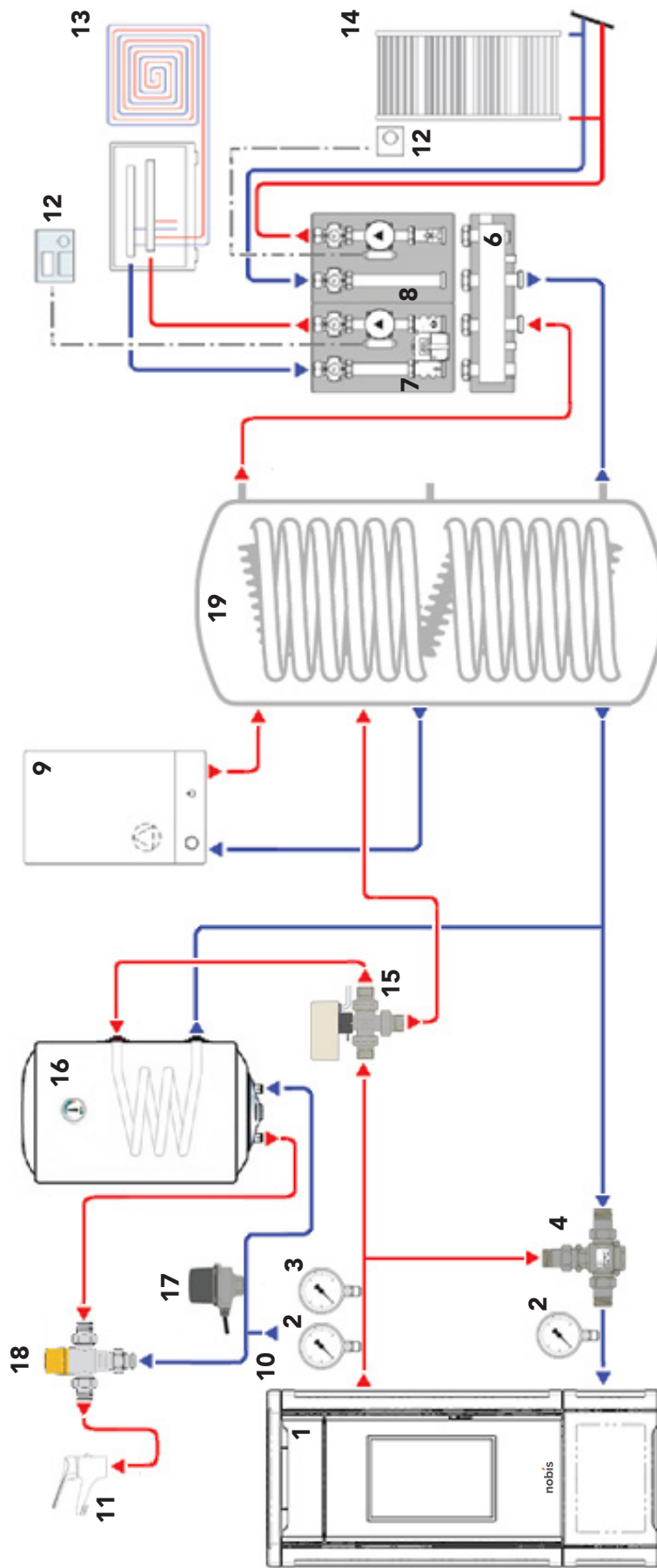
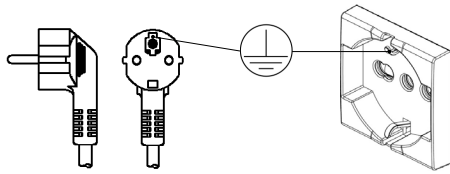

DIAGRAM 03 - TECHNICAL WATER (PUFFER) + DHW TANK

- 1 - Pellet stove
- 2 - Thermometer
- 3 - Pressure gauge
- 4 - Anti-condensation valve
- 5 - System separator
- 6 - System manifold
- 7 - Mixed distribution group
- 8 - Direct distribution group
- 9 - Gas boiler
- 10 - Water duct
- 11 - Sanitary water
- 12 - Wall thermostat
- 13 - Floor heating
- 14 - Heating with radiators
- 15 - Three-way heating valve
- 16 - DHW storage tank (Boiler)
- 17 - DHW flow switch
- 18 - Mixing valve
- 19 - Technical water storage tank (hot water tank)



! It is compulsory for the system to be grounded and have a differential switch in compliance with current laws. Also, ensure the socket is compatible with the type of plug on the power cable used.



5 MAINTENANCE

Maintenance operations, excluding routine cleaning (explained in the relevant paragraph), must be carried out by authorized, technical staff. Remember, before carrying out any maintenance operation, to implement the following precautions:

- all parts of the product must be "cold";
- ensure there is no form of combustion whatsoever (for example hot ash);
- use safety devices as per directive;
- remove the plug from the electrical socket;
- once maintenance has been carried out, reset the product paying attention to re-activate all the safety devices.

5.1 MAINTENANCE OF THE SMOKE SYSTEM

The chimney flue must always be kept clean, since deposits of soot or fuel residue reduce the flow rate, blocking the tube's draught, thus compromising good operation of the product and, if in large quantities, cause fire. It is mandatory to have the chimney cleaned and checked by a qualified chimney sweep at least once a year or after a prolonged stop for non-use of the appliance. At the end of the check/maintenance, ask for a report to be issued stating that the system is safe. Failure to clean jeopardizes the safety of the system.

5.2 PRODUCT MAINTENANCE

Carry out maintenance at least once a year or on each "Service Hours" signalling (signal appearing on screen when the limit of working hours, over which excellent operation is not guaranteed, have been exceeded).

In this phase, the authorized technician should:

- completely and accurately clean the smoke pipes;
- check the sealing status of all the gaskets;
- remove crushed pellet residue inside the pellet tank;
- re-assemble all parts of the appliance;
- check correct operation and good quality of combustion.

6 TECHNICAL DATA OF THE PRODUCT

This chapter gives the end user all information related to the technical data of the product, its dimensions, installation measurements, minimum distance to from walls and furniture, sofas, etc. to be observed.

6.1 PRODUCT DATA SHEET

PRODUCT DATA SHEET		
EU 2015/1186		
Brand	Nobis	
Model	H14 V SHAPE ROUND	H17 V SHAPE ROUND
Energy efficiency class	A++	A++
Direct thermal power (Kw)	3.2	2.9
Indirect thermal power (Kw)	14.6	16.9
Energy efficiency index	134	133
Useful efficiency (Nominal power %)	94.2	93.5
Useful efficiency (Reduced power %)	94.8	94.8
Comply with the warnings and instructions for installation and periodic maintenance of the instructions manual.		

6.2 TECHNICAL FEATURES

Modello	H14 V SHAPE ROUND		H17 V SHAPE ROUND	
	Reduced	Nominal	Reduced	Nominal
Weight of appliance (kg)	228		254	
Water quantity (lt)	15		15	
Min. working pressure (bar-kPa)	1 - 100		1 - 100	
Max. working pressure (bar-kPa)	2.5 - 250		2.5 - 250	
Ø air inlet (mm)	60		60	
Ø smoke outlet pipe (mm)	80		80	
Vol. max. heating* (m ³)	437		486	
Power introduced (kW)	8.8	18.9	8.8	21.2
Yield introduced (kW)	8.4	17.8	8.4	19.8
Water output power (kW)	6.6	14.6	6.6	16.9
Yield (%)	94.8	94.2	94.8	93.5
CO 13% O ₂ (%)	0.0023	0.0013	0.0023	0.0021
Tank capacity (kg)	21		21	
Pellet hourly consumption (kg/h)	1.89	4.05	1.89	4.54
Autonomy (h)	11.1	5.2	11.1	4.6
Absorbed electrical power (W)	305		305	
Electrical power supply (V-Hz)	230-50		230-50	
Discharge gas flow (g/s)	7.7	10.6	7.7	11.8
Minimum draught (Pa)	10	10	10	10
Smoke temperature (°C)	94	141	94	156

* this value can vary based on the type of energy class of the home and the type of pellet used.

The data outlined are approximate and non-binding and can vary based on the type of pellet used. The manufacturer reserves the right to make changes for the purpose of improving product performance.

6.3 DIMENSIONS

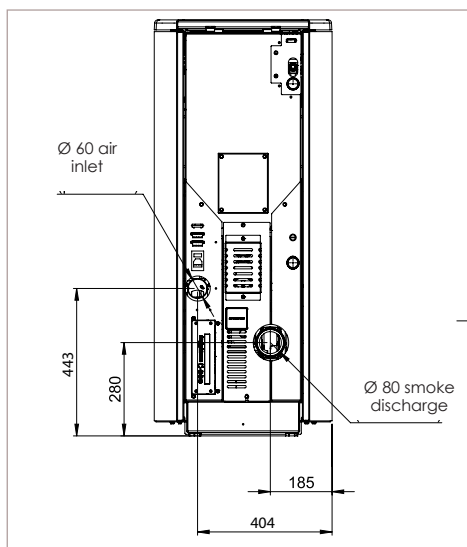
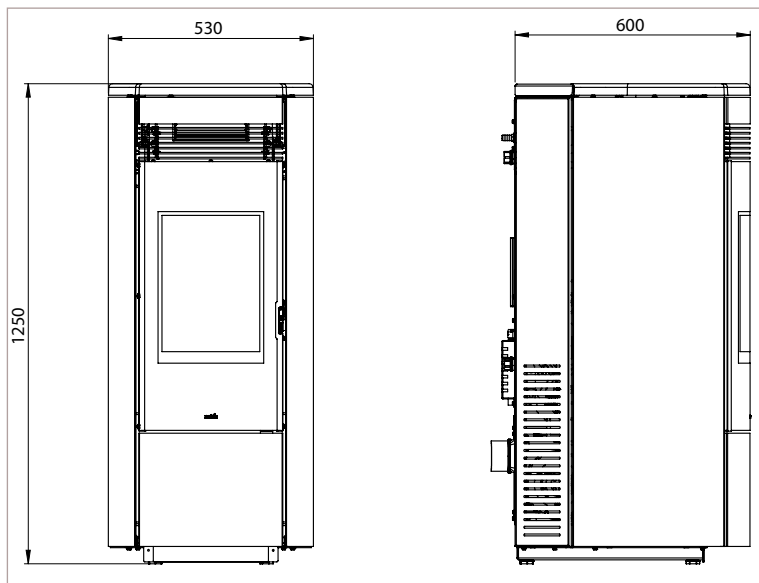

6.4 SAFE DISTANCES

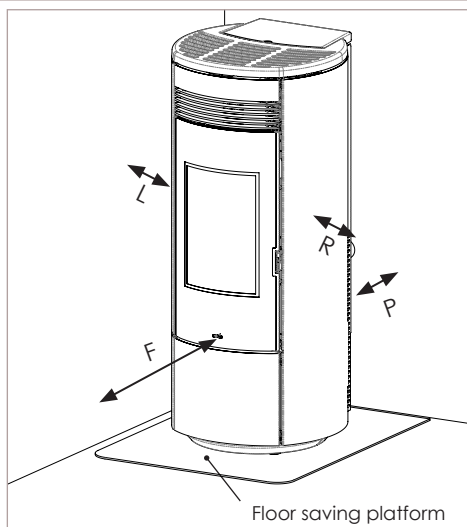

Distanza minima da materiali infiammabili		
R	Right hand side	300 mm
L	Left hand side	300 mm
P	Rear	300 mm
F	Front	1000 mm

7 PRODUCT CONFIGURATION

Once installation, assembly of the coverings (where present as a kit) and electrical connection have been duly carried out, access the rear part of the product to power it.

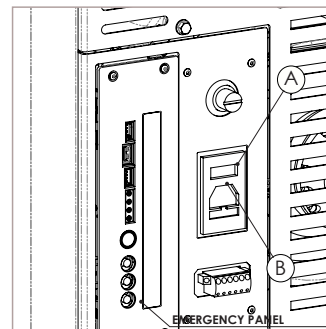

The "I/O" (A) switch in the figure above must be positioned on "I". In the event of a power failure, check the condition of the fuse placed under the switch (B) (4A fuse EU configuration). During periods of non-use, you are advised to disconnect the cable powering the appliance, and also the batteries from the remote control.

7.1 CONFIGURATION OF THE REMOTE CONTROL

Remove the protective cover of the batteries on the rear of the remote control, as shown in figure (A), and insert 3 batteries (type AAA Alkaline 1.5V) in the remote control compartment, paying attention to polarity. Close the protective cover of the batteries as shown in figure (B).

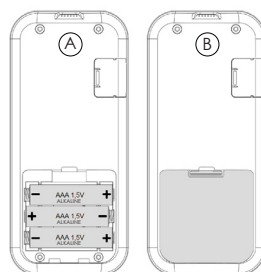

Once exhausted, the batteries must be disposed of in a dedicated collection center. To protect batteries from adverse conditions or misuse, remember to:



- keep the remote control away from heat sources, risk of explosion;
- remove the batteries in case of long periods of non-use of the remote control, risk of oxidation and liquid leakage;

Nobis srl declares that the type of "Handheld" radio device complies with Directive 2014/53/EU. Full text of the EU declaration of conformity is available at the following Internet address:

<https://www.nobisfire.it/wp-content/uploads/2019/04/DoC-Palmare-Radio-Nobis-1.pdf>

After showing a first short screen with the manufacturer's logo, the remote control will list all languages in which the menu is available.



Select your standard language, using the keys  . Press  to confirm and move on to the next screen.

To work properly, the remote control requires interfacing with the electronic board inside the product. For this reason, the display will show the following installation message.

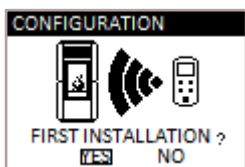

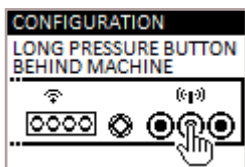

If this is the first use of the remote control, choose **YES** with the selection keys  . Press  to confirm and move on to the next screen.

Follow the instructions to link the appliance to the display via remote, as showed in the figure below.

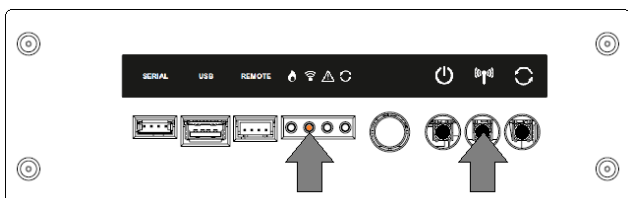

Keep the remote communication key  of the electronic board (placed on the rear of the product) pressed for a few seconds to start the unit search procedure.



The yellow, flashing led, under the icon  indicates that the electronic board is waiting for the remote control signal.

Press the confirmation key  on the remote control to make the components communicate with one another.

A tick sign on the display, accompanied by an acoustic signal, indicates that the remote connection operation has been carried out successfully.



If the batteries are replaced, you don't necessarily have to follow the initialization procedure of the remote control once again. In this case, when the display will show the message "FIRST INSTALLATION?", select **NO** and press the confirmation key .

7.2 CONFIGURATION OF EXT. THERMOSTAT

If you want to manage the appliance from a different room (i.e. where the remote control cannot communicate), you can connect an external thermostat to the product, to adjust combustion or, by activating a particular function, switch the product on/off. As shown in the figure below, connect the terminals of the thermostat to the terminal board on the back of the product (near the emergency panel).

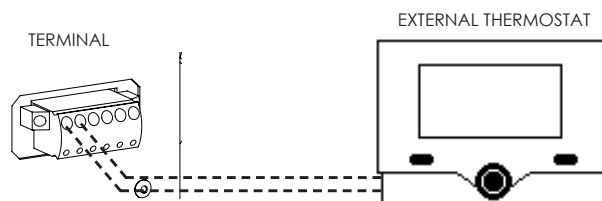

Once the electrical connection has been carried out, it is necessary to activate the recognition function from the SETTINGS menu to allow the control unit to recognize the presence of the external thermostat (see paragraph: "ENABLE EXTERNAL THERMOSTAT").

 By enabling the function that enables the external thermostat, reading and management of room temperature are inhibited on the remote control. The remote control will display TON when a higher temperature is required, TOFF if the temperature set on the thermostat has been reached.

7.3 PELLETT LOADING

Fuel is loaded by opening the door and inserting pellets from the upper part of the product. Please, make sure that pellets contained in the bag do not fall around the edges of the tank, paying particular attention to centering while loading. Also, avoid the packaging of the pellets to enter in contact with hot surfaces.

 Make sure you close the cover of the tank properly after loading pellets. Closure is controlled by an electronic contact (when applicable). In case of failure to close, a warning signal notifies the user to pay attention to closure. A further alarm will be activated in case the warning is disregarded.

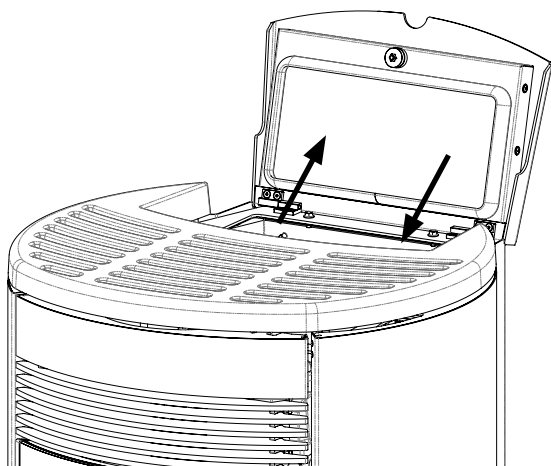

8 DESCRIPTION OF THE REMOTE CONTROL

Before switching on the appliance, it is recommended to read the following chapter carefully (pertaining the use of the receiver and the remote control, as well as their related functions).

INFORMATION NOTE:

- frequency bands and transmitted power used by the equipment, as reported in technical documentation: 868.3MHz - 869.85MHz
- frequency bands and respective power limits transmitted applicable to the device (frequency and standardized power): 6dBm ERP

8.1 DESCRIPTION OF THE RECEIVER

The appliance is equipped with an emergency remote board, placed on the back of the product, which allows to manage some basic functions in the event the remote control is faulty or not working properly.

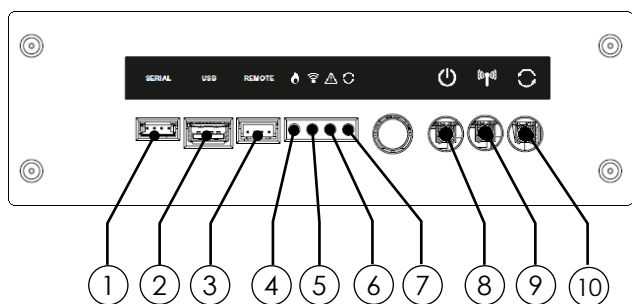

- 1 Serial connection (to be used by authorized staff ONLY)
- 2 USB connection (to be used by authorized staff ONLY)
- 3 Emergency cable connection
- 4 GREEN LED - appliance working status
- 5 YELLOW LED - remote communication in progress
- 6 RED LED - alarm on
- 7 BLUE LED - System updating in progress
- 8 Appliance switch on/off button
- 9 Receiver - remote control pairing button
- 10 Manual upgrade button (use by authorized staff ONLY)

i In the event of malfunctioning of the remote communication between the remote control and the receiver, or if batteries are flat, please use the **emergency cable** supplied to restore communication between the remote devices.

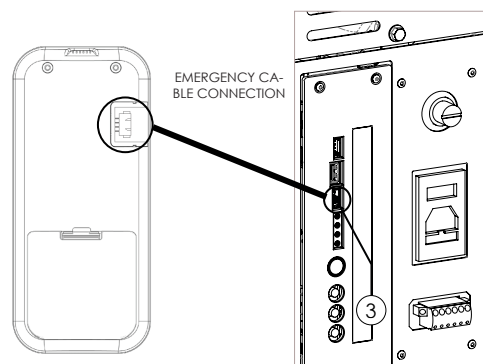

! Before connection using the emergency cable, remove the batteries from the remote control. FIRE HAZARD

8.2 DESCRIPTION OF THE REMOTE CONTROL KEYS

The remote control appear as in the image shown below:

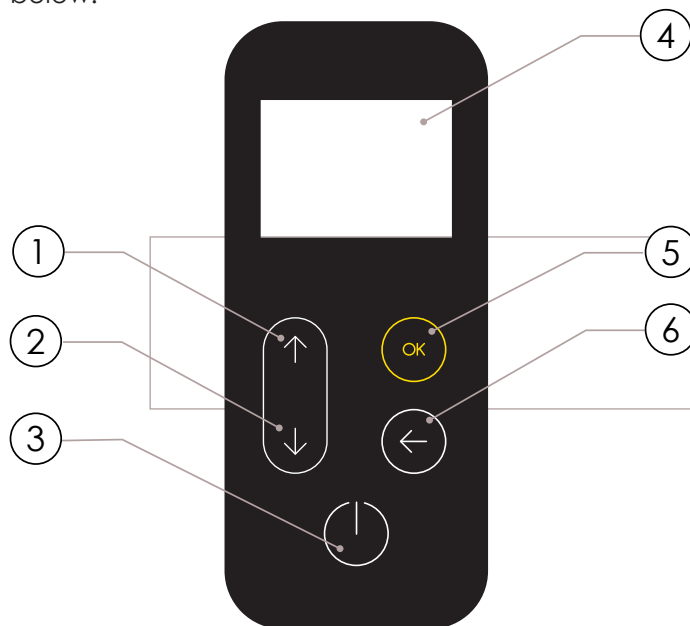

- 1 'Increase' key (selection key)
- 2 'Decrease' key (selection key)
- 3 ON/OFF or reset from "Sleep" mode key
- 4 Display
- 5 'MENU access' and 'Confirm' key
- 6 Back to previous screen

i When in "Sleep" mode, the screen of the remote control is blacked out, only maintaining enabled, if necessary, the remote communication with the appliance, to reduce battery consumption.

8.3 DESCRIPTION OF THE REMOTE CONTROL DISPLAY

The remote control display will appear as follows:

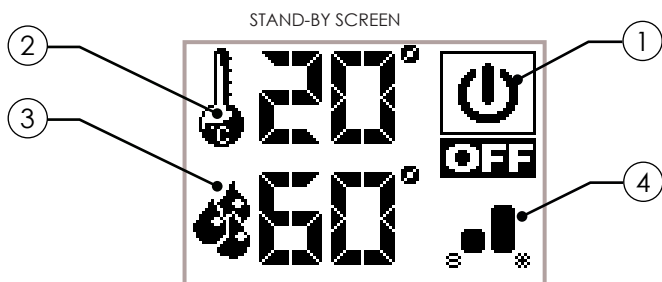

i After 20 seconds of inactivity, the display on the remote control blacks out and passes to "SLEEP" mode, maintaining the remote connection with the appliance. The display will re-enable by simply by pressing the **(1)** key.

- ① Icon indicating the status of the appliance (see "Icons Overview").
- ② Indicates the working power set. Moreover, by pressing the scroll key **(↑)** will allow temperature settings to be displayed and then edited by using the two scroll keys **(↑/↓)**. Confirmation of each variation takes place automatically within 3 seconds from the editing of data, or by pressing the confirmation **(OK)** key. An acoustic signal will confirm the change.



- ③ It shows boiler water actual temperature as detected by the probe placed upstream in the system. Moreover, temperature settings can be viewed by pressing **(↓)** and then edited by pressing the two scroll buttons **(↓/↑)**. Any change in temperature settings is confirmed either automatically - within 3 seconds from the last change - or by pressing **(OK)** button. An acoustic signal will confirm the change.



- ④ It shows power settings.



From STAND-BY mode, press **(←)** to get an overview of the actual and active device status, as shown in the following figure:

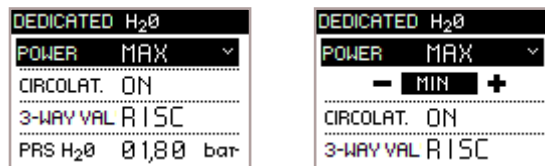

Press **(OK)** to edit the appliance working power by means of the scroll keys **(↑/↓)**.

POWER: it shows the appliance power, which can be

- MINIMUM: minimum editable power
- MAXIMUM: maximum editable power (see specific section)
- ECO: product modulation when setting values are reached;
- SANI: indicates dedicated power – in case of need – if a rapid DHW kit is installed or else a particular system has been installed.

Each time the appliance is turned on, it always activates at maximum power;

PUMP: The word 'ON' indicates that the circulator is active and is in the process of circulating water in the house system.

3-WAY VALVE: Indicates the positioning of any three-way valve installed, if in the presence of a DHW exchanger or a DHW tank.

PRESSURE: Indicates the actual pressure of the system read by the transducer, placed on the product upstream.

8.4 FLAT BATTERIES SIGNAL

If batteries are flat, the display will show a symbol indicating their limit status, maintaining the functions of the remote control enabled anyway.

As soon as the battery level does not allow any remote communication anymore, the remote control will display a full screen image of a flat battery, blocking all other functions connected to it until the batteries are replaced.



8.5 ICONS OVERVIEW

①	②	③	④	MEANING
				START
				MAX. WORKING POWER
				MIN. WORKING POWER
				SANITARY MODE
	MAN			MANUAL ROOM TEMPERATURE CONTROL MODE
				ROOM TEMPERATURE SAVING MODE
				BOILER H ₂ O TEMPERATURE SAVING MODE
				DIRECT SYSTEM + DHW STORAGE SETTING MODE
				TECHNICAL H ₂ O STORAGE MODE
				TECHNICAL H ₂ O STORAGE + DHW STORAGE MODE
				OPTIMIZED MODE (see specific paragraph)
				BRAZIER CLEANING (if applicable)
				ACTIVE CLEANER (cleaning and brazier emptying)
				ACTIVE COMFORT CLIMA
				RESTART FROM COMFORT CLIMA
				FINAL CLEANING
				OFF
				ALERT (see specific paragraph)
				FLAME OVERHEATING
				PELLET OVERLOAD

①	②	③	④	MEANING
				H ₂ O STANDBY
				FAULTY PRESSURE SENSOR
				FAULTY FLAME PROBE
				REMOTE CONTROL BATTERIES ALMOST FLAT
				LIMIT OF SERVICE HOURS REACHED

9 MENU BROWSING

To access the menu, press the key on the standby screen to display the selection items, as in the figure below.

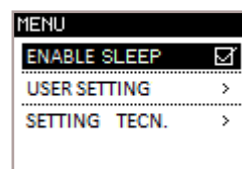

Scroll the menu items pressing

Confirm the selection with the key

To return to the previous item, press

A practical example of how to browse the menu using all the selection keys is illustrated below.

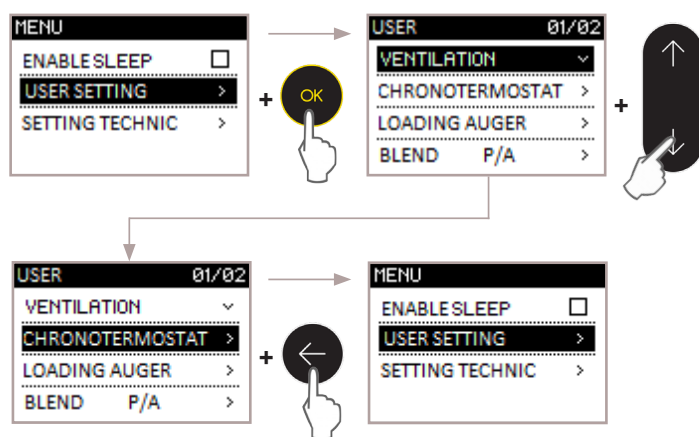

10 FIRST START-UP INSTRUCTIONS

This chapter highlights a series of operations to carry out during the first start-up phase of the appliance.

10.1 HOUR-DATE SETTINGS

The procedure follows to set the date and time, useful for the thermostat with timer function, on the models of the manufacturer's range.

OPERATING PROCEDURE:

MENU >> USER >> SETTINGS >> HOUR - DATE

Access the menu by pressing **OK**

Scroll the entries to USER with **↓**

Access the menu by pressing **OK**

Scroll the entries to SETTINGS with **↓**

Access the menu by pressing **OK**

Scroll the entries to HOUR-DATE, using **↓**

Once you reach the HOUR-DATE menu item, press **OK**

The screen appears to adjust the time and calendar as in the figure below.

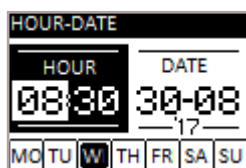

Edit the highlighted data using the keys **↑** **↓**

Confirm the data changed by pressing **OK**

Repeat the operation to complete the settings.

While editing, remember the following:

- to return to the previous data without saving the last data changed, press **←**
- if you are going to change one single datum, once the change has been made, press **OK** repeatedly to exit the function described in the paragraph.

To go back to the STAND-BY screen, press **←** repeatedly.

10.2 PROBE ADJUSTMENTS

The following procedure explains how to calibrate all probes, should the value differ from the values shown on a reference standard thermostat.

OPERATING PROCEDURE:

MENU >> USER >> SETTINGS >> PROBE ADJUSTMENTS

Access user menu by pressing **OK**

Scroll down entries to select SETTINGS using **↓**

Access the menu by pressing **OK**

By pressing **↓**, scroll down entries to select SETTINGS

Access the menu by pressing **OK**

Scroll down entries **↓** to select PROBE ADJUSTMENTS

Press **OK** to access PROBE ADJUSTMENTS

The probe adjustments screen will appear as in the figure below.

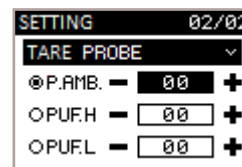

Adjust the highlighted value by pressing **↑** **↓**
 Example: the reference thermostat displays 21°C, while the controller displays 19°C.
 Set +2 to display 21°C on the controller.

Confirm your change by pressing **OK**

To go back to the STAND-BY screen, press **←** button repeatedly.

10.3 ROOM TEMPERATURE SETTINGS

The ambient temperature defines the temperature you want to obtain in the premises where the product is installed.

From the STAND-BY screen, key **↑** to select the value;

The values vary from 7°C to MAN (with the MAN value it is intended that, once set, the appliance NEVER goes to power save).

Edit the value with the keys **↑** **↓**

Confirm the new setting with the key **OK** or wait 3 seconds for auto-confirm.

10.4 FIREPLACE POWER SETTINGS

Fireplace power defines the quantity of heat produced by the appliance. This entails a difference in fuel consumption. Basically, it is used to speed up the useful time to reach the desired room temperature in the premises where the product is installed.

From the STAND-BY screen, key **↓** to select the desired power;

Values vary from 1 to 7;

Edit values with keys **↑** **↓**

Confirm the new settings with the key **OK** or wait 3 seconds for auto-confirm.

i Each time the appliance is turned on, it ALWAYS turns on at maximum power to guarantee the greatest amount of heat to the heating system.

10.5 SWITCHING ON/OFF THE PRODUCT

To switch on the product, long press key  until the following screen appears, followed by an acoustic signal.



This screen will be displayed for the following machine statuses:

- SWITCH ON** • Pellet loading initial phase;
- WAITING FLAME** • Flame development waiting phase;
- FLAME PHASE** • Flame and oxidizer stabilization phase inside the brazier;

The screen is accompanied by the "flame" symbol with the writing ON, without displaying the power level. To switch off the product, long press key . The operation will be followed by acoustic signal and any alarms will be reset.



i For models equipped with an automatic cleaner, during the switch on phase, the product activates a brazier cleaning phase before switching on. In the event of FAILED IGNITION, after pressing the button, a POP UP will signal the need to suck the pellet from the brazier before turning the appliance back on, thus avoiding discharge of unburned pellets into the ash drawer.

! Always vacuum the brazier using an ash cleaner, FIRE HAZARD.

i During the first start-up of the product, either unpleasant odours or smoke caused by evaporation or drying of certain materials used may occur. This phenomena will disappear after some hours of use. During this period, you are advised to keep the premises well ventilated.

11 OPERATION

Products in the range include an operation phase with 2 operating powers. Once the room-temperature values - if set - are reached, the appliance will behave as follows.

11.1 SAVING MODE

During operation, the appliance operates so as to reach room-temperature and boiler-water values as they have been set by the User; once such conditions are fulfilled, power will be decreased until SAVING mode is enabled, a phase in which fuel consumption is at its lowest.

SAVING mode screen when desired room temperature is reached:



SAVING mode screen when desired Boiler water settings are reached:



SAVING mode screen with both settings reached:



11.2 COMFORT CLIMA FUNCTION

As described in the "saving mode" paragraph, the appliance is intended to meet the user's heating requirements. The function which can be enabled, linked to his mode, also ensures - if the home has a good energy class - fuel saving through intelligent switch off of the product (once values are reached as per settings).

Please find below the procedure to be followed in order to enable the function, as well as a list of values and their pertaining meaning, as well as a practical example.

OPERATING PROCEDURE:

MENU >> USER>> COMFORT CLIMA

Access the menu by pressing key **OK**

Scroll the entry to USER with the key **↓**

Access the menu by pressing key **OK**

Scroll the entries to COMFORT CLIMA, key **↓**

On the COMFORT CLIMA menu entry, key **OK**

The screen for activating the function with its settings/adjustments entries will appear.

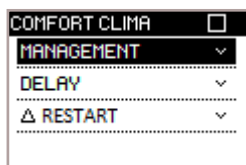

Activate/deactivate this function by pressing **OK** (a checkmark will appear/disappear accordingly):

- Go back to USER SETTINGS by pressing **←**.

OR

- By pressing **↓**, go to the entry selection to make any changes to the function. Press **OK** to access the adjustments screen.

Press **↑****↓** to make changes and press **OK** to confirm.

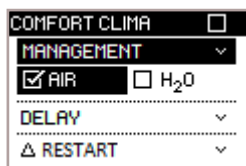
Function settings (room temperature or boiler H₂O)

It allows to activate the product shutdown when ARIA room-temperature or boiler H₂O settings are reached (at the user's own discretion).

Delayed shutdown

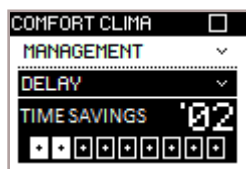

Time needed to determine whether the set temperature (room temperature/boiler H₂O) remains constant before shutdown.

Delta restart

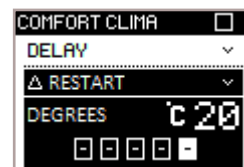

This setting determines the temperature needed for the appliance to restart.

While modifying the parameters above, just press **←** to go back to the previous entry without saving.

To go back to the STAND-BY screen, press **←** button repeatedly.

STATUS SCREEN:

To display the appliance shutdown on the display while in COMFORT CLIMA mode, screen **1** must be displayed.

To see that the appliance is about to start in COMFORT CLIMA mode, screen **2** must be displayed.



PRACTICAL EXAMPLE:

How to manage comfort on ARIA

Set room temperature at 21°C;

Set 3 minutes for the saving mode;

Set the temperature you wish the appliance to restart at 2°C lower than the previously set value.

The appliance will shut down as soon as room temperature reaches the set value + 3 minutes in saving mode.

The product will restart when a temperature of 18°C (with a tolerance of, i.e. 21°C - 2°C - 0,5°C) is detected. It is also possible to activate this function by using an external thermostat, bearing in mind that this does not include the hysteresis value.

i You are advised to use an external thermostat with its hysteresis value settable up to a maximum of 3°C. While in operation, the appliance may start the switch on and off phase many times during the day; this could compromise the duration of switch on resistance.

11.3 H₂O STANDBY

"H₂O Standby" mode is activated when water temperature reaches 85°C; this function takes over to protect the circuit, especially when no COMFORT CLIMA function is activated for the boiler H₂O. The appliance will restart automatically after cooling down, provided that a power-on request is set. (i.e.: room temperature request).

11.4 VENTILATION MANAGEMENT (if applicable)

The products in the range equipped with a ventilation system can heat the environment where they are installed not only by means of the heat generated through the glass, but also through their specific fan.

OPERATING PROCEDURE:

MENU >> USER SETTINGS >> VENTILATION

Access the menu by pressing **OK**

Scroll down entries to select USER SETTINGS using **↓**

Access the menu by pressing **OK**

Press **OK** on "VENTILATION" (first menu entry)

The screen with the ventilation adjustments will appear as shown in the figure below.

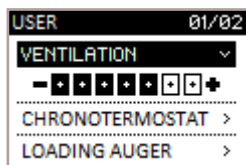

Change ventilation power by pressing **↑** **↓**

0 – ventilation deactivated;
1-7 – ventilation power range

Confirm by pressing **OK** button.

To go back to the STAND-BY screen, press the **←** button repeatedly.



Upon request to your technician, ventilation can be thermostated so as to turn it off - once the temperature in the room where the product is installed has been reached - by means of the remote control and using only an external thermostat for the device environmental management.

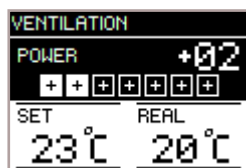
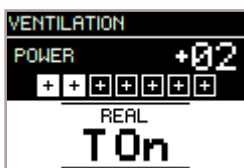

12 DESCRIPTION OF THE MENU FUNCTIONS

This chapter describes the user menu functions useful to improve some comfort-related aspects of the user and/or operation of the product.

12.1 THERMOSTAT WITH TIMER FUNCTION

With the chronothermostat, you can: program, for each day of the week, automatic switch on and off of the product, with 4 independent time intervals (PROGRAM 1 - 2 - 3 - 4). The steps to follow are outlined below, starting with the STAND-BY screen, to access the relevant menu.

OPERATING PROCEDURE:

MENU >> USER >> THERMOSTAT TIMER

Access the menu by pressing key **OK**

Scroll the entries to SET USER, key **↓**

Access the menu by pressing key **OK**

Scroll the entries to THERMOSTAT TIMER, key **↓**

Access the function with the key **OK**

The screen with activation of the function and the possibility of selecting 4 TIMED setting programs, will appear as illustrated in the figure below.

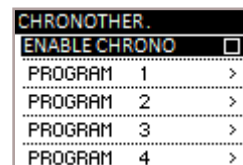

Enable/disable the function with the key **OK** (to tick/untick it) and:



- Return to SETUSER with the key **←**.

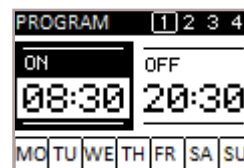

OR

- Pass, using the key **↓**, to the choice of program to set, before accessing with the key **OK** to change it.

If you want to access 1 of the 4 programs, the screen will appear as shown in the image below:



To edit the switch on/off times, as well as enabling the days of the week, press keys  
Confirm each data change using the key  and move on to the second screen of the TIMER program.



The screen in the figure below shows the settings options for both desired room temperature and maximum boiler-water temperature during the activation of the time frame . It is also possible to control the ventilation speed (if applicable) .



Edit the values using the keys  

Confirm each data change using the key  until you exit the program.

While editing, remember the following:

- press  to return to the previous data, without saving the last data changed;
- if you intend to change one single datum, once the change has been made, press  multiple times until you exit the function.

To return to the STAND-BY screen, press  repeatedly.

12.2 AUGER LOADING FUNCTION

This function is necessary to facilitate the switch on phase of the appliance, after accurate cleaning of the hopper (pellet container) to remove sawdust - which accumulates on its base over time - has been carried out. See the chapter "Routine maintenance of the product" for further info.

Also, make sure that pellets have been properly loaded in the tank and that the appliance is in the "OFF" or "FINAL CLEANING" status before activating this function.

The number - expressed in seconds - indicates the rotation time of the auger during the loading phase. After this time is up, the auger stops automatically, and the appliance can switch on.

OPERATING PROCEDURE:

MENU >> USER >> AUGER LOADING

Access the menu by pressing key 

Scroll the entries to USER with the key 

Access the menu by pressing 

Scroll the entries to AUGER LOADING and press 

Access the function by pressing key 

The cleaner activates (for models equipped with automatic cleaning) and then pellet loading is enabled. The display will show a countdown: as it reaches "0", the loading will stop.

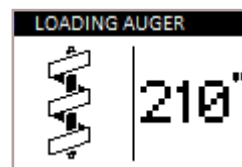

At the end of the loading phase, the appliance will show the USER screen.

 After the initial loading phase, a POPUP will appear, indicating the sucking of pellets from the brazier. This operation does not allow emptying the pellets into the ash drawer when the plate is rotating during ignition.

 Always vacuum the brazier using an ash cleaner. FIRE HAZARD.

12.3 PELLET/AIR-INTAKE RATIO

The PELLET/AIR-INTAKE RATIO settings allow you to change, with immediate effect, the quantity of pellets loaded in the brazier and the quantity of air in-bound of the product, tested and inspected with DIN PLUS certified pellets. If you use other pellets or uncertified pellets, combustion may need to be adjusted. Normally, the change is performed on the EXTRACTION percentage to improve combustion; if oxygen adjustment is not efficient, you may need to also change the percentage of PELLETS falling.

OPERATING PROCEDURE:

MENU >> USER >> P/A RATIO

Access the menu by pressing key 

Scroll the entries to USER, key 

Access the menu by pressing key 

Scroll the entries to P/A RATIO with the key 

Access the function by pressing key 

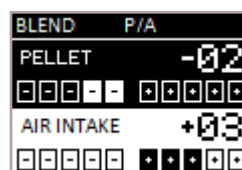

Edit the pellet setting by using keys  

The values vary from -5: reduction in pellet load (%)
to +5: increase in pellet load (%)

Confirm by pressing the key  and move on to edit extraction.

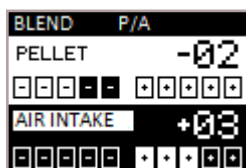

To edit the extraction setting, use keys  

The values vary from -5: reduction in extraction (%)
to +5: increase in extraction in (%)

Confirm by pressing  and exit the adjustments screen to return to the SETTINGS screen.

In the example outlined above, a percentage of -2 PELLETS and +3 EXTRACTION was set; this kind of setting results from the fact combustion is lacking oxygen and the pellets are small in size, if compared to the average 2cm type.

During editing, remember the following:

- to return to the previous data, without saving the last data changed, press 
- if you intend to change one single datum, once the change has been made, press  multiple times until you exit the function.

To return to the STAND-BY screen, press  repeatedly

 The number indicated for the settings change refers to a change in percentage which acts on the default parameters set on the electronic board. This only affects the operating phase. These values should be changed in the event of poor combustion, which, in many cases, is due to use of pellets different from those used for testing the appliance.

12.4 STOVE STATUS

This function allows you to check if most important parameters are working properly on the appliance. The two screens below show the list of actual data of the product, useful for the support service during control operations.

OPERATING PROCEDURE:

MENU >> USER >> STOVE STATUS

Access the menu by pressing key 



Scroll the entries to USER with the key 

Access the menu by pressing key 

Scroll the entries to STOVE STATUS with the key 

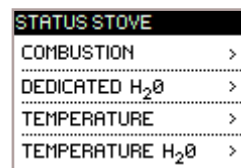
Access the function by pressing key 



Select the type of screen you want to display with the keys  

Access the relevant screen with the key 

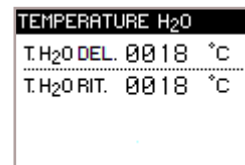
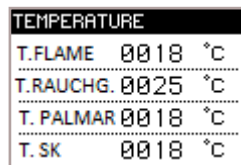
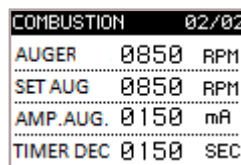
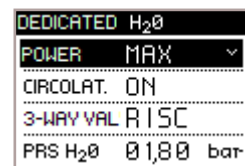
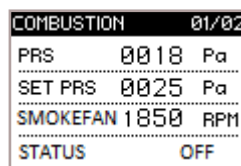

To return to the SET USER screen, press 

To return to the STAND-BY screen, press  repeatedly.

12.5 ENABLING THE EXTERNAL THERMOSTAT

This paragraph explains how to enable the function allowing to manage room temperature by means of the external thermostat instead of using the remote control. Being a continuation of the paragraph called "CONFIGURATION OF EXT. THERMOSTAT", this section explains the procedure for the reading of the device by means of the electronic board.

OPERATING PROCEDURE:

MENU >> USER >> SETTINGS >> ENABLE T.EXT

Access the user menu by pressing key 



Scroll the entries to SETTINGS with the key 

Access the menu by pressing key 

Scroll the entries to SETTINGS with the key 

Access the menu by pressing key 

The first item on the menu, ENABLE T.EXT.

Tick using the key  if you want to manage room temperature with the external thermostat (not supplied) .

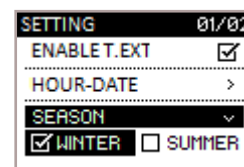

Select season by pressing  

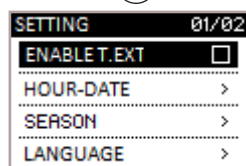
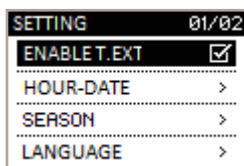

Press  to confirm season and visualize the checkmark.

Press the  button repeatedly to go back to the STAND-BY screen.



To return to the STAND-BY screen, press  repeatedly.

Instead of detected and settable room temperature the STAND-BY screen will display the following:

- the writing T ON if the room in which the thermostat is installed has not reached the required temperature yet; 
- the writing T OFF if room temperature has been reached. 





12.6 SEASON

This function controls the blocking of the three-way valve (advanced diagrams), thus preventing hot water from being supplied to the heating system in the presence of a DHW storage tank (with SUMMER settings).

OPERATING PROCEDURE:

MENU >> USER >> SETTINGS >> SEASON

Access the menu by pressing key 

Scroll down entries to select USER using 

Access the menu by pressing key 

Scroll down entries to select SETTINGS by pressing 

Access the menu by pressing key 

Scroll down entries to select SEASON by pressing 

Access function by pressing key 

12.7 LANGUAGE

Depending on the country of destination or the end user, this function includes a series of languages among which to choose. The procedure to choose the desired language is described below.

OPERATING PROCEDURE:

MENU >> USER >> SETTINGS >> LANGUAGE

Access the menu by pressing key 

Scroll the entries to USER with the key 

Access the menu by pressing key 

Scroll the entries to SETTINGS with the key 

Access the menu by pressing key 

Scroll the entries to LANGUAGE with the key 

Access the function by pressing key 



Select the language by pressing the keys  

Confirm the language by pressing  and displaying the tick sign.

To return to the STAND-BY screen, press  repeatedly.

12.8 CONTRAST

Below you can find the procedure to improve the screen display settings.

OPERATING PROCEDURE:

MENU >> USER >> SETTINGS >> CONTRAST

Access the menu by pressing key 

Scroll the entries to SETTINGS with the key 

Access the menu by pressing key **OK**

Scroll the entries to SETTINGS with the key **↓**

Access the menu by pressing key **OK**

Scroll the entries to CONTRAST, key **↓**

On the function item, press with key **OK**

The screen to adjust the remote control contrast will appear as in the image below.

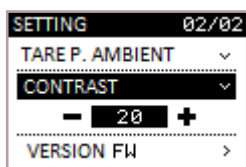

Edit the highlighted data using the keys **↑****↓**

Confirm the data changed by pressing **OK**

To return to the STAND-BY screen, press **←** repeatedly.

12.9 FIRMWARE VERSION

To view the version of the firmware installed for the appliance model supplied, follow the procedure in this paragraph. This function is useful for the support centre to control availability of new updates to be installed, if necessary.

OPERATING PROCEDURE:

MENU >> USER >> SETTINGS >> FW VERSION

Access the menu by pressing key **OK**

Scroll the entries to USER with the key **↓**

Access the menu by pressing key **OK**

Scroll the entries to SETTINGS with the key **↓**

Access the menu by pressing key **OK**

Scroll the entries to FIRMWARE VERSION with the key **↓**

Access the function by pressing key **OK**

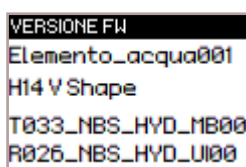

To return to the STAND-BY screen, press **←** repeatedly.

12.10 ANTICONDENSATION (exhaust fumes temperature)

This function ensures that the exhaust fumes temperature remains higher than condensate temperature.

i Enabling this function will result in a slight increase of pellet consumption to remedy this condition. Causes of condensation can be related to installation and, above all, to the yield of the pellets and its size.

OPERATING PROCEDURE::

MENU >> USER >> SETTINGS >> ANTICONDENSATION

Access the menu by pressing key **OK**

Scroll the entries to USER with the key **↓**

Access the menu by pressing key **OK**

Scroll the entries to SETTINGS with the key **↓**

Access the menu by pressing key **OK**

Scroll the entries to ANTICONDENSATION with the key **↓**

Activate/deactivate the function by pressing **OK**



To return to the STAND-BY screen, press **←** repeatedly.

12.11 SLEEP FUNCTION (TURBULATORS)

The appliance, belonging to the ACQUA range, is equipped with an autonomous tube-bundle cleaning system, which acts by moving the turbulators inside of it. This function can be activated to inhibit its activity during night-time operation. A deactivation time frame is set by default from 10.00 PM to 8.00 AM the following day.

OPERATING PROCEDURE:

MENU >> ENABLE SLEEP

Access the menu by pressing **OK**

Activate/deactivate SLEEP mode by pressing **OK**

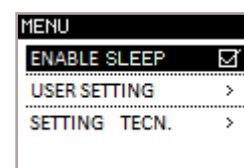

To return to the STAND-BY screen, press  repeatedly.

i The turbulators are activated automatically each time the appliance is switched on/off and by means of a timer during operation. It never occurs when the machine is not active.

GENERAL INFORMATION NOTE:

When you switch from one screen to another, the following screens will be displayed for a few seconds:

①



This screen indicates that the remote control is trying to communicate with the appliance, which is needed to recover the information to be displayed to the end user. ①

If communication is absent, the writing FIELD, followed by an ID code will appear. In this case, simply move closer to the appliance to re-establish communication. ②

②

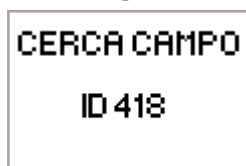

13 ADVANCED HYDRAULIC DIAGRAMS

This paragraph describes the behavior of the remote control when a system diagram different from the standard one (that is, when the device is operating directly with the heating system) is activated. Activating such diagram (operation reserved for a specialized technician), while maintaining the same menu functions, the screen adapts to the display of all connected utilities, such as the DHW storage tank temperature or the technical H₂O storage tank.





i In case the type of system diagram designed requires the management of the 3-way valve (diagram 1 and 3), it is necessary to purchase an optional kit at a Nobis authorized sales point or technician.



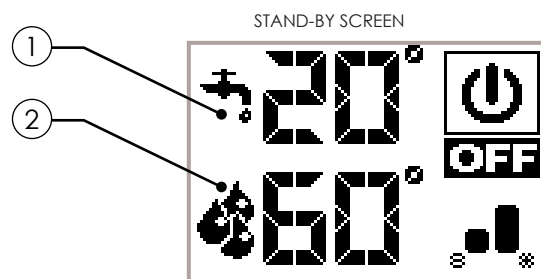

13.1 DIAGRAM 01 (DHW STO. TANK + HEATING)

The following diagram can be used when a boiler without a plate heat exchanger is in use and the User wants to buy an accumulator (boiler) to be connected to the circuit, in order to produce domestic hot water. In this kind of circuit, the room temperature is managed by the remote control which, having a radio connection, acts as a remote chronothermostat.

The DHW storage is managed by the appliance thanks to a contact or immersion probe (not provided) to be connected on the back side of the product. The new stand-by screen is shown below.



① It shows the DHW storage temperature as detected by the probe. Temperature settings – editable by pressing   – can be shown by pressing  scroll buttons. Any change in temperature settings is confirmed either automatically - within 3 seconds from the last change – or by pressing  button. An acoustic signal will confirm the change.

② It shows boiler water actual temperature as detected by the probe. Moreover, temperature settings – editable by using   – can be shown by pressing  scroll buttons. Any change is confirmed either automatically - within 3 seconds from the last change – or by pressing  button. An acoustic signal will confirm the change.

The operation is the same as the one described in the basic diagram, with the only difference that, here the product exchanges directly in the DHW storage (priority); when the set temperature is reached, the three-way valve changes its position and the appliance begins to exchange in the heating circuit. From this moment on, heating can be managed by using the remote control to set the room temperature as well as H₂O temperature (see diagram 00 operation related to modulation, eco stop, etc.). The three-way valve redirects itself to the DHW storage when:

- it is required by the storage tank itself;
- it is required by the flow switch (optional, if connected)

From ECOSTOP or H₂O STANDBY status, the product restarts considering heating or DHW accumulator settings.

i By setting SUMMER mode, the three-way valve remains fixed, allowing heat produced by the appliance to be transferred only inside the DHW storage tank. As soon as this condition is reached, the product switches to ECO STOP mode.

13.2 DIAGRAM 02 (TECHNICAL H₂O STORAGE TANK)

In this type of circuit, technical H₂O storage tank is managed by the product thanks to a contact or immersion probe (not provided) to be connected to the back side of the appliance.

The new stand-by screen is shown below.

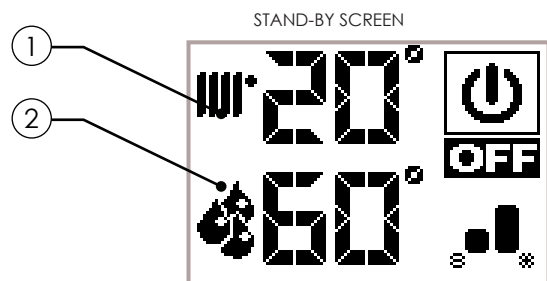

- ① It shows the technical water storage tank temperature as detected by the probe. Temperature settings – editable by pressing \downarrow \uparrow – can be shown by pressing \uparrow scroll button. Any change in temperature settings is confirmed either automatically - within 3 seconds from the last change – or by pressing OK button. An acoustic signal will confirm the change.

- ② It shows the boiler water temperature as detected by the probe. Temperature is not editable.

The operation is the same as the one of the basic diagram, with the only difference that, with this diagram, the product exchanges directly in the technical water storage tank. As soon as the set temperature is reached, the appliance switches to ECOSTOP status and then restarts if the temperature drops below a re-ignition value (Delta restart settable by the installer at time of testing).

13.3 DIAGRAM 03 (DHW + TECHNICAL H₂O STORAGE TANKS)

The following diagram combines the functions of the other diagrams described previously and is suggested to those having a technical water storage tank (hot water tank) without the internal coil for domestic water use. In this type of circuit, the DHW storage tank is managed by the appliance by means of a contact or immersion probe (not provided) to be connected on the back of the product. The same applies for the management of H₂O storage where the appliance manages the heating by means of a contact or immersion probe (not provided), always to be connected on the back of the product.

The new stand-by screen is shown below.

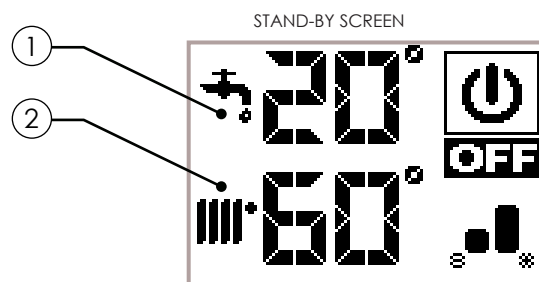

- ① It shows the DHW storage tank temperature as detected by the probe. Temperature settings – editable by pressing \downarrow \uparrow – can be shown by pressing \uparrow scroll button. Any change in temperature settings is confirmed either automatically - within 3 seconds from the last change – or by pressing OK button. An acoustic signal will confirm the change.

- ② It shows the technical water storage tank temperature as detected by the probe. Temperature settings – editable by pressing \downarrow \uparrow – can be shown by pressing \uparrow scroll button. Any change in temperature settings is confirmed either automatically - within 3 seconds from the last change – or by pressing OK button. An acoustic signal will confirm the change.

The operation is the same as the one of the basic diagram, with the only difference that, with this diagram, the product exchanges directly in the DHW storage tank (priority); when the set temperature is reached, the three-way valve changes its position and the appliance begins to exchange in the technical water storage (hot water tank). As soon as the set temperature is reached, the appliance switches to ECOSTOP status and then restarts if the temperature drops below a re-ignition value (Delta restart settable by the installer at time of testing).









The three-way valve redirects itself again to the DHW storage tank when:

- it is required by the storage tank itself;
- it is required by the flow switch (optional, if connected)





From ECOSTOP or H₂O STANDBY status, the product restarts considering the requests of one of the two storage tanks.

i By setting SUMMER mode, the three-way valve remains fixed, allowing heat produced by the appliance to be transferred only inside the DHW storage. As soon as this condition is reached, the product switches to ECO STOP mode.





14 PHASES OVERVIEW

PHASE	DESCRIPTION
 <p>START WAITING FOR FLAME FLAME PHASE</p>	<p>-The resistor preheating phase starts and pellet begins to fall into the brazier.</p> <p>- Pellet ignites by means of the incoming hot air passing through the conduit of the glowing resistor.</p> <p>- A further pellet load helps develop the flame.</p>
 <p>OPERATING</p>	<p>The appliance has carried out the ignition phase and reaches the working power as per settings.</p>
 <p>ECO</p>	<p>The desired room temperature has been reached.</p>
 <p>ECO</p>	<p>The maximum settable boiler-water temperature has been reached.</p>
 <p>BRAZIER CLEANING</p>	<p>The brazier cleaning phase is active without the cleaner being moved (periodic function).</p>
 <p>ACTIVE CLEANER</p>	<p>The active brazier cleaning phase is on. The appliance will shutdown and restart automatically.</p>
 <p>RESTART</p>	<p>Restart is required after cooling. Once such condition is achieved, the appliance will start automatically.</p>
 <p>FINAL CLEANING</p>	<p>The appliance is preparing for shutdown and the cooling phase has not finished yet.</p>
 <p>OFF</p>	<p>The appliance is OFF and all engines are deactivated.</p>





15 FUNCTIONS OVERVIEW



PHASE	DESCRIPTION
 <p>MAN OPERATION</p>	<p>Room temperature set on MAN mode. In this case the appliance will operate only when the power of the combustion chamber has been set (if NEVER switches to eco mode).</p>
 <p>THERMOSTAT</p>	<p>Room temperature control by an external thermostat (not supplied by the manufacturer) has been selected.</p>
 <p>COMFORT CLIMA</p>	<p>When Comfort Clima is active, the product will shut down automatically as soon as all setting values are reached. (see specific paragraph).</p>
 <p>OPTIMA FLAME</p>	<p>The appliance optimizes combustion by reducing the pellet load, while still guaranteeing its performance.</p>

16 ALERTS OVERVIEW

PHASE	DESCRIPTION
 <p>AL - 05 ALARM</p>	<p>The appliance is in alarm status. Please check the "ALARMS" chapter for more information.</p>
 <p>ANOMALY</p>	<p>The appliance reports an anomaly without shutting down. See "17 ANOMALIES OVERVIEW".</p>
 <p>BATTERY 10%</p>	<p>Batteries in the remote control have a low level of energy.</p>
 <p>HRS SERVICE</p>	<p>The set threshold of service hours has been reached. It is recommended to request an extraordinary maintenance service by authorized personnel.</p>
 <p>H₂O STANDBY</p>	<p>Forced shutdown when H₂O temperature reaches 85 °C. The product restarts automatically if restart conditions occur.</p>

17 ANOMALIES OVERVIEW

PHASE	DESCRIPTION
 <p>FAULTY PRESSURE PROBE</p>	The appliance signals a malfunction of the sensor controlling proper combustion. For safety purposes, while waiting for the technician, the appliance is set to saving mode.
 <p>HOT FUMES</p>	The maximum smoke temperature threshold has been reached; the appliance will set to saving mode for a certain period, with ventilation at maximum power to cool the body.
 <p>PELLET OVERLOAD</p>	The quantity of pellets loaded is too high for the machine. In P/A RATIO, reduce the pellet load by adjusting the % (see specific paragraph).
 <p>FAULTY FLAME PROBE</p>	The appliance signals a malfunctioning of the probe which detects the flame. For safety purposes, while waiting for technical intervention, the appliance sets to saving mode.

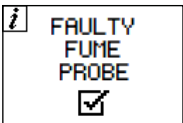
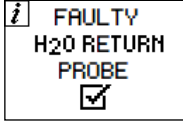
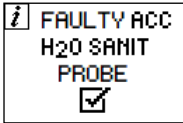
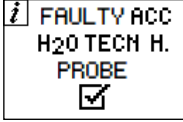
PHASE	DESCRIPTION
 <p>OPEN PELLET LID</p>	The anomaly is presented when the user opens the door, the ash pan or the pellet door; at this point, pellet loading inside the brazier stops and the electronics will emit an acoustic signal. The user has to close the doors to make the product work again operation. If this operation is not carried out, the product will signal an alarm.
 <p>DOOR / ASH DRAWER OPEN</p>	
 <p>FAULTY FUME PROBE</p>	Anomaly of the probe controlling the temperature of the discharge smoke. Contact an authorized technician to solve the malfunctioning.
 <p>FAULTY H2O RETURN PROBE</p>	Anomaly to the probe monitoring the system return H ₂ O temperature: contact an authorized technician to solve the malfunctioning.
 <p>FAULTY ACC H2O SANIT PROBE</p>	Anomaly to the probe monitoring the water temperature in the DHW storage tank (Boiler); please, contact an authorized technician to solve the problem.
 <p>FAULTY ACC H2O TECH H. PROBE</p>	Anomaly to the upstream probe monitoring the water temperature in the technical water storage tank (hot water tank); please contact an authorized technician to solve the problem.

i Anomalies, (which are not to be confused with "alarms"), are signals which reset automatically once the issue that caused them to activate has been solved. Moreover, the signalling will not cause the appliance to switch off, thus guaranteeing the product to keep on heating the room.

! Some anomalies require technical intervention by authorized staff in order to be solved. Despite the appliance continuing to work, the user must make sure the problem is solved. **Negligence will cause malfunctioning.**

18 DESCRIPTION OF ALARMS

ALARM CODE	REASON
01 BLACKOUT	No power during operation.
	SOLUTION
	Press the switch-off key and then switch the appliance back on. If the problem persists, contact the Support Service..

ALARM CODE	REASON
02 NO SWITCH ON	The pellet tank is empty.
	INadequate pellets calibration and suction during the start-up phase.
	Ignition resistor faulty or out of its position.
SOLUTION	Check for the presence of pellets in the tank. If necessary, load some. If the problem persists, contact the Support Service.

ALARM CODE	REASON	
03 PELLETS FINISHED	The pellet tank is empty.	
	The gearmotor is not loading pellets.	
	Lack of pellets.	
	SOLUTION	Check for the presence of pellets in the tank. If necessary, load some. Empty the tank to check that there are no objects inside it. Adjust, by increasing the load of pellets, from "P/A RATIO" If the problem persists, contact the Support Service.

ALARM CODE	REASON
04 SMOKE TEMPERATURE	Combustion in the brazier is not optimal because either it is clogged or the inner passages of the appliance are clogged.
	The tangential fan (if present) is not working properly or it is damaged.
	SOLUTION
	Switch the product off and back on again, activating the cleaner; adjust combustion using the "P/A RATIO" function.
	If the problem persists, contact the Support Service.

ALARM CODE	REASON
05 INSUFFICIENT EXTRACTOR ROTATION SPEED	The rotations of the smoke extractor show a loss of efficiency due to obstruction of the fan or a drop in voltage.
	SOLUTION
	If the problem persists, contact the Support Service..

ALARM CODE	REASON
06 FAULTY SMOKE EXTRACTOR	No power supply to the smoke extractor.
	The smoke extractor is blocked.
	SOLUTION
	If the problem persists, contact the Support Service..

ALARM CODE	REASON
07 GEARMOTOR ROTATIONS NOT RESPECTED PELLET LOADING	The gearmotor rotation speed is losing efficiency due to a drop in voltage.
	SOLUTION
	If the problem persists, contact the Support Service..

ALARM CODE	REASON
08 FAULTY PELLET-LOADING GEAR MOTOR	Gearmotor encoder not working or not connected correctly.
	No power to gearmotor.
	SOLUTION
	If the problem persists, contact the Support Service..

ALARM CODE	REASON
09 PELLET-LOADING AUGER BLOCKED	Possible foreign body or sawdust preventing correct movement.
	SOLUTION
	Empty the tank and check for foreign bodies.
	If the problem persists, contact the Support Service.

ALARM CODE	REASON
10 PELLET-LOADING AUGER: FAULTY POWER SUPPLY	No power supply or power supplied by the electronic control unit is inadequate.
	SOLUTION
	If the problem persists, contact the Support Service.

ALARM CODE	REASON
11 MINIMUM PRESSURE PASCAL	The sensor does not detect intake negative air pressure in the appliance.
	SOLUTION
	Make sure that both the door and ash pan are closed properly, check whether the air intake tube is obstructed.
	If the problem persists, contact the Support Service.

ALARM CODE	REASON
12 FAULTY BRAZIER CLEANER	The cleaner has not completed its movement and it is not in the right position, or else the fire door has not been closed properly.
	SOLUTION
	Check if the door is closed correctly, reset the alarm and wait for the product to switch off. Disconnect and reconnect the power: the system will re-activate the cleaner, checking for its position once again.
	If the problem persists, contact the Support Service.

ALARM CODE	REASON
13 NEGATIVE PRESSURE IN THE CHIMNEY FLUE	The chimney flue is blocked.
	The sensor detecting negative pressure is not working properly.
	SOLUTION
	Make sure that the chimney flue is not clogged: contact a chimney sweep to clean it.
	If the problem persists, contact the Support Service.

ALARM CODE	REASON
14 THERMOSTAT MANUAL RESET	The thermostat connected to the hopper has to be reset manually.
	Combustion in the brazier is not optimal as the brazier is clogged or the inner passages of the appliance are clogged.
	Ventilation, where present and active, may not be working properly.
	SOLUTION
	Reset the thermostat by pressing the specific button on the back of the appliance.
	Switch off the product and then back on again to activate the cleaner and adjust combustion by means of the P/A RATIO function.
	If the problem persists, contact the Support Service.

POSITION OF THE MANUAL RESET THERMAL SWITCH

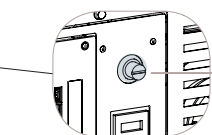
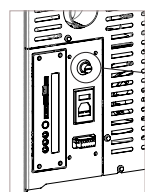

MANUAL RESET THERMAL SWITCH

Unscrew the safety cap and press the thermal switch reset button

ALARM CODE	REASON
15 FIRE DOOR/ ASH PAN OPEN	During the cleaning phase of the product, the fire door - or the ash pan - was not closed properly.
	SOLUTION
	Make sure that the fire door has been closed properly and/or the ash pan has been duly inserted in its compartment. If the problem persists, contact the Support Service.

ALARM CODE	REASON
16 PELLET TANK DOOR OPEN	The tank door has not been closed properly during the pellet loading phase.
	SOLUTION
	Make sure that the pellet tank door has been closed properly. If the problem persists, contact the Support Service.

ALARM CODE	REASON
18 FLAME PROBE	Simultaneous flame probe and smoke probe fault.
	SOLUTION
	Contact the Technical Support.

ALARM CODE	REASON
19 MINIMUM H₂O PRESSURE	System pressure is less than 0.5 bar (a cold circuit pressure of about 1 bar is recommended).
	SOLUTION
	Fill the system to bring the pressure back to the required value for proper functioning. If the problem persists, please contact the Assistance Service.

ALARM CODE	REASON
20 MAXIMUM H₂O PRESSURE	System pressure is more than 2.5 bar (a cold circuit pressure of about 1 bar is recommended).
	SOLUTION
	Vent the system to bring the pressure back to the required value for a proper functioning. If the problem persists, please contact the Assistance Service.

ALARM CODE	REASON
21 BOILER H₂O TEMPERATURE	The temperature of the boiler upstream H ₂ O is above 90°C.
	SOLUTION
	Please contact the Assistance Service.

ALARM CODE	REASON
22 FLAME TEMPERATURE	Combustion in the brazier is not optimal as the brazier is clogged or the inner passages of the appliance are clogged.
	The tangential fan (if present) is not working properly or is damaged.
	SOLUTION
	Switch the product off and back on again, activating the cleaner; adjust combustion by means of the "P/A RATIO" function. If the problem persists, contact the Support Service.

ALARM CODE	REASON
23 AUGER TRIAC	Anomaly of an internal component of the electronic board managing the pellet loading auger.
	Possible drops in voltage or wrong voltage input to the device.
	SOLUTION
	Check power supply voltage. If the problem persists, contact the Support Service.

ALARM CODE	REASON
24 AUGER PHASE	No cable connection to give power to the auger gearmotor.
	SOLUTION
	If the problem persists, contact the Support Service.

ALARM CODE	REASON
25 BOILER H₂O FAILURE	The upstream boiler H ₂ O probe does not work properly.
	The boiler H ₂ O probe is disconnected from the electronic board.
	SOLUTION
	Please contact the Assistance Service.

ALARM CODE	REASON
26 PUMP PWM ARREST	The pump impeller is blocked: unscrew the front screw and activate the impeller manually.
	SOLUTION
	If the problem persists, contact the Support Service.

ALARM CODE	SOLUTION
27 PUMP FAILURE	The pump does not work properly or cannot start.
	SOLUTION
	If the problem persists, contact the Support Service.

ALARM CODE	REASON
28 SMOKE ENCODER REVOLUTION FAILURE	Smoke extractor encoder not working or not connected properly.
	SOLUTION
	If the problem persists, contact the Support Service.

ALARM CODE	REASON
29 CLEANING CYCLE LIMIT	Maximum limit of cleaning cycles allowed during a prolonged working phase has been reached.
	SOLUTION
	Vacuum the brazier in full safety and switch the product on again. If the problem persists, contact the Support Service.

19 CLEANING THE APPLIANCE

! Product installation must take place in such a way as to ensure easy access to the appliance itself and to the flue for cleaning and maintenance operations.

! Please carefully adhere to the following instructions for correct cleaning of the appliance. Non-compliance could cause its malfunctioning.

Before carrying out any cleaning operation on the appliance, take the following precautions:

- switch off the product and in "OFF" status disconnect the power supply cable;
- ensure all the parts are cold to touch;
- ensure the combustion ash is completely out.

To clean the surfaces, on the painted metal parts, use a cloth soaked in water and soap. Use of abrasive detergents or diluents causes damage to the surface of the product.

19.1 CLEANING THE FIREPLACE

Open the fire door using its specific tool and:

- vacuum the slide bringing the ash to the brazier;
- disassemble the flame trap, vacuum the compartment hidden by the flame trap (paying utmost attention not to damage the sensor placed behind the flame trap).

OPERATING PROCEDURE:

Open the fire door using the specific lever supplied with the product as illustrated in the figure below:

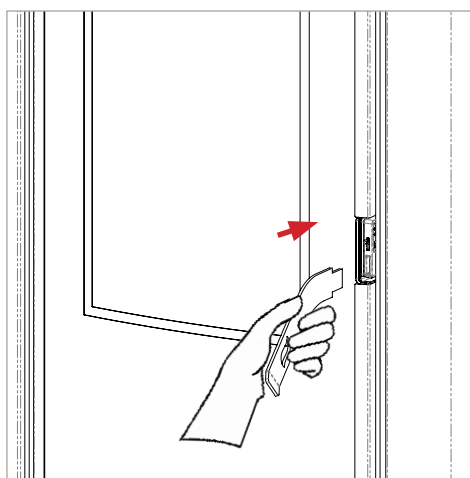

Insert the lever (supplied with the product) in its specific slot, as illustrated in the figure below:

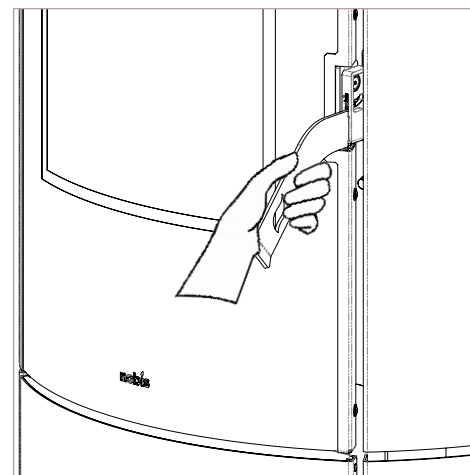

Lift the lever (supplied with the product) to unlock and open the door as illustrated in the figure below:

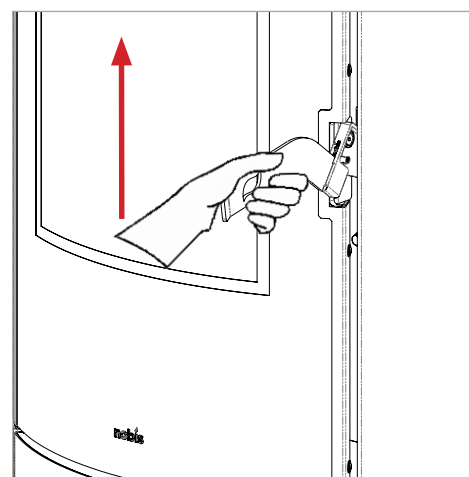

To extract the flame trap, lift it slightly as in the figure below:

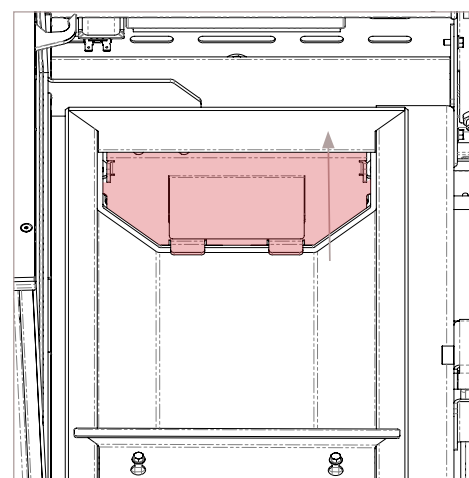

Remove it by pulling the lever towards you with a slight movement downwards, as shown in the figure below:

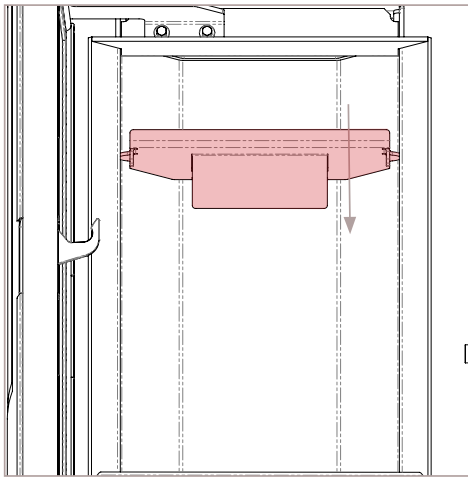

With a soft bristle brush, get rid of the combustion particulate, sweeping it into the slide beneath.

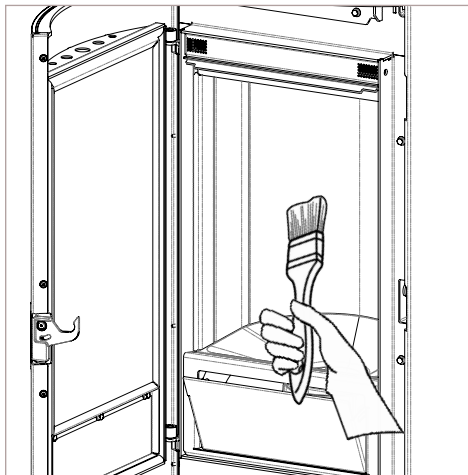

Vacuum the slide, the hatch and the surface hidden by the flame trap, paying attention not to bump the nozzle of the vacuum cleaner into the vermiculite.

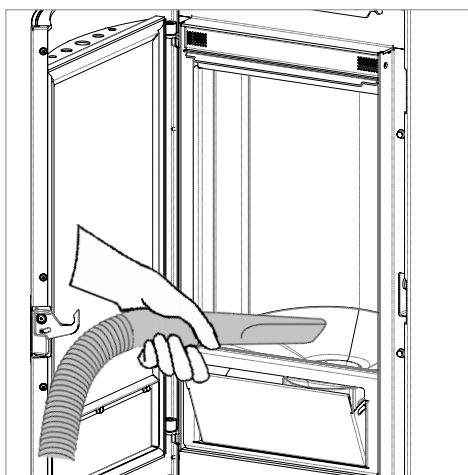

19.2 CLEANING THE GLASS DOOR

To clean the glass, use a cotton cloth or kitchen paper. It is recommended to clean the glass using a cloth damp with a mixture of water and combustion ash (abrasive effect), avoiding the use of products with additives which could, over time, wear out seals, glass and paint.

i Do not switch on the appliance if the glass is damaged.
Contact the support service to replace it.

OPERATING PROCEDURE:

Clean with a cotton cloth as illustrated in the figure below:

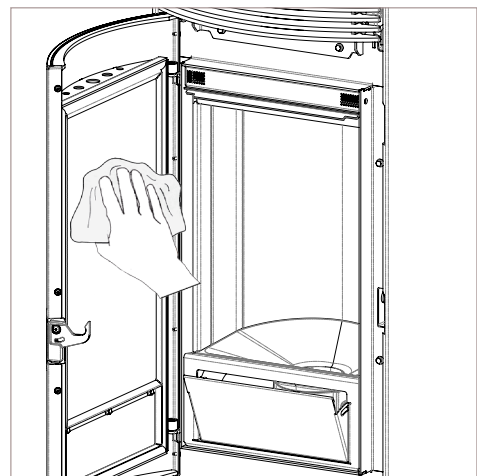

19.3 CLEANING THE ASH PAN

Remove the pan from the appliance and then remove the ash deposit from it, using an ash vacuum cleaner; pay utmost attention to the presence of embers that could still be hot and which could damage the appliance used for cleaning.

i Cleaning operations depend on the quality of the pellets used and on how frequently the product is used. Therefore, the user may need to carry out such operations more frequently than stated in the manual.

OPERATING PROCEDURE:

Open the door under the fire door, as in the figure below:

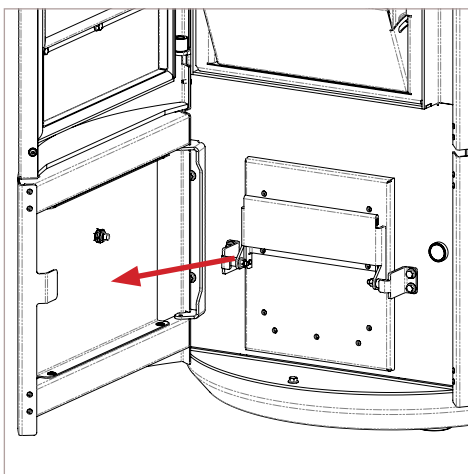

Open the ash pan using the handle, as in the figure below:

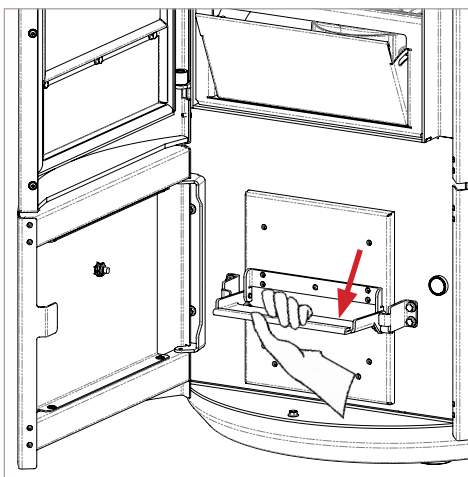

Remove the ash pan and empty it, as in the figure below:

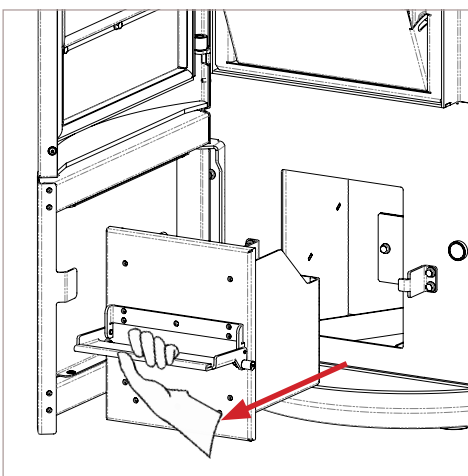

TABLE OF CLEANING CYCLES

Essential control and/or maintenance intervention for proper operation are summarised below.

PARTS/FREQUENCY	TIME
Ash pan (approx. time)	7 DD
Glass	2-3 DD
Extraction pipe *	1 SE
Door seal/ash pan*	1 SE
Tube bundle scraper (where present)	7 DD
Chimney flue	1 SE
Combustion chamber	2-3 DD
Vacuum pellet tank	30 DD
Electromechanical components*	1 SE

LEGEND:

* - operations which can be carried out by an authorized technician;

DD - day/s

SE - season

MAINTENANCE

DATE	INTERVENTION CARRIED OUT

20 WIRING DIAGRAM

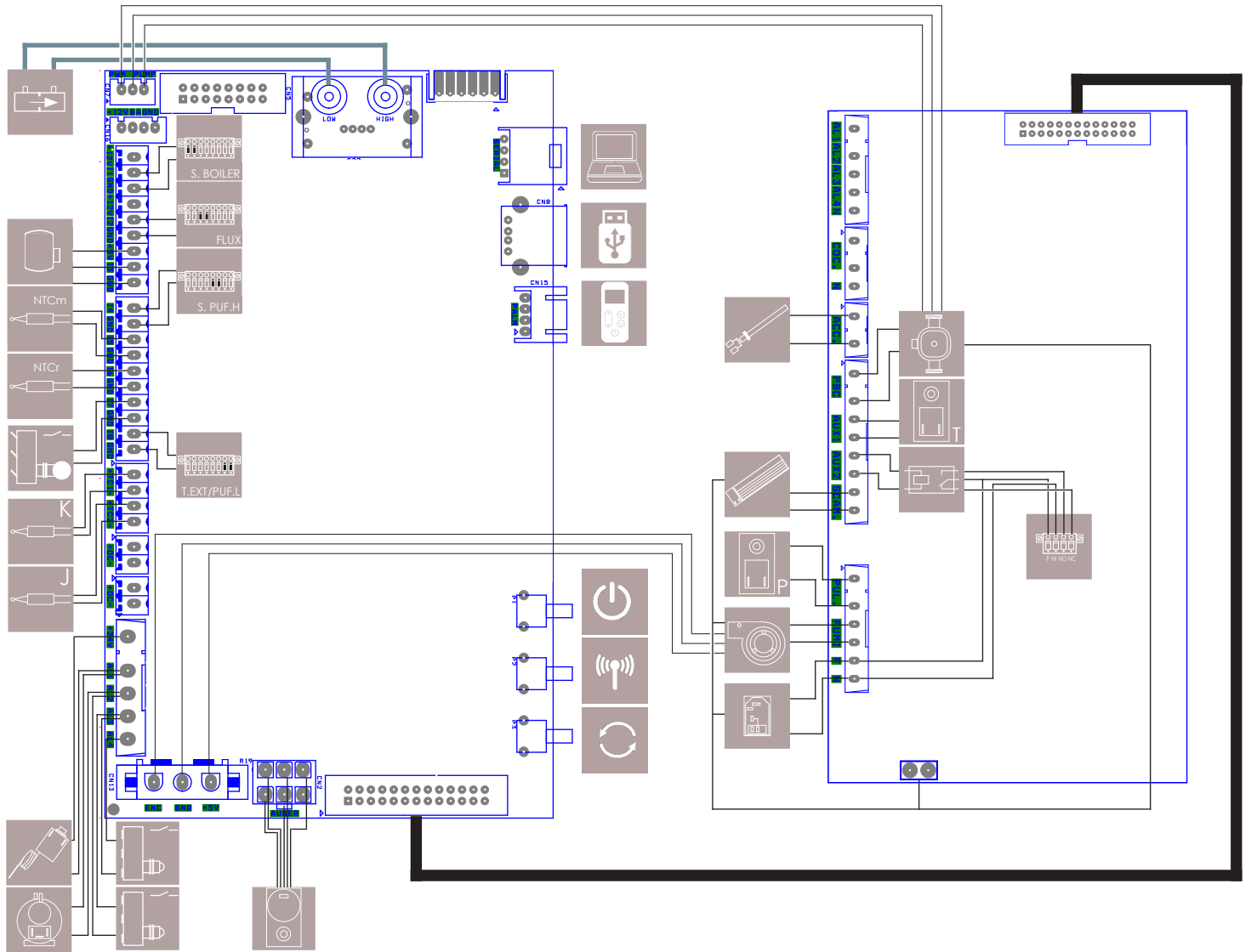

LEGEND:

	PRESSURE SENSOR		SMOKE EXTRACTOR		SAFETY VACUUM SWITCH		REMOTE UNIT SELECTION BUTTON
	STROKE COUNTER MECHANICAL CLEANER		MANUAL RESET THERMAL SWITCH		FRONT VENTILATION		FW UPGRADE BUTTON (technical support only)
	EXT.THERM./HOT WATER TANK (LOW) TERMINAL CONNECTION		SWITCH ON RESISTOR		PC CONNECTION (technical support only)		BOILER WATER CIRCULATOR
	FLAME PROBE		GEARMOTOR MECHANICAL CLEANER		USB CONNECTION (technical support only)		TERMINAL HOT WATER TANK (HIGH)
	SMOKE PROBE		CONTACT DOOR/ ASH PAN (1) PELLET TANK (2)		EMERGENCY CABLE REMOTE CONTROL		TURBULATORS GEAR MOTOR
	GEARMOTOR BLDC 24V		220V SOCKET WITH ON/OFF SWITCH AND FUSE		APPLIANCE SWITCH-ON BUTTON		TERMINAL FLOW-SWITCH CONNECTION
	SYSTEM SUPPLY PROBE		SYSTEM RETURN PROBE		TERMINAL DHW TANK (BOILER) CONNECTION		SYSTEM H ₂ O PRESSURE-DETECTION FLOW SWITCH
	RELAY + TERMINAL 3-WAY VALVE CONNECTION						



NOBIS srl

Via Palazzolo N.11
25037 - Pontoglio - BS
www.nobisfire.it

Nobis Srl cannot be held in any way liable for any errors in this manual and considers itself free to change the features of its products without prior warning.

Cod.110-002-0030N_S1